

EATON

Fluid Power

Hydro-Line Cylinders

IHM Series Cylinders
ISO 6020-2 Interchangeable

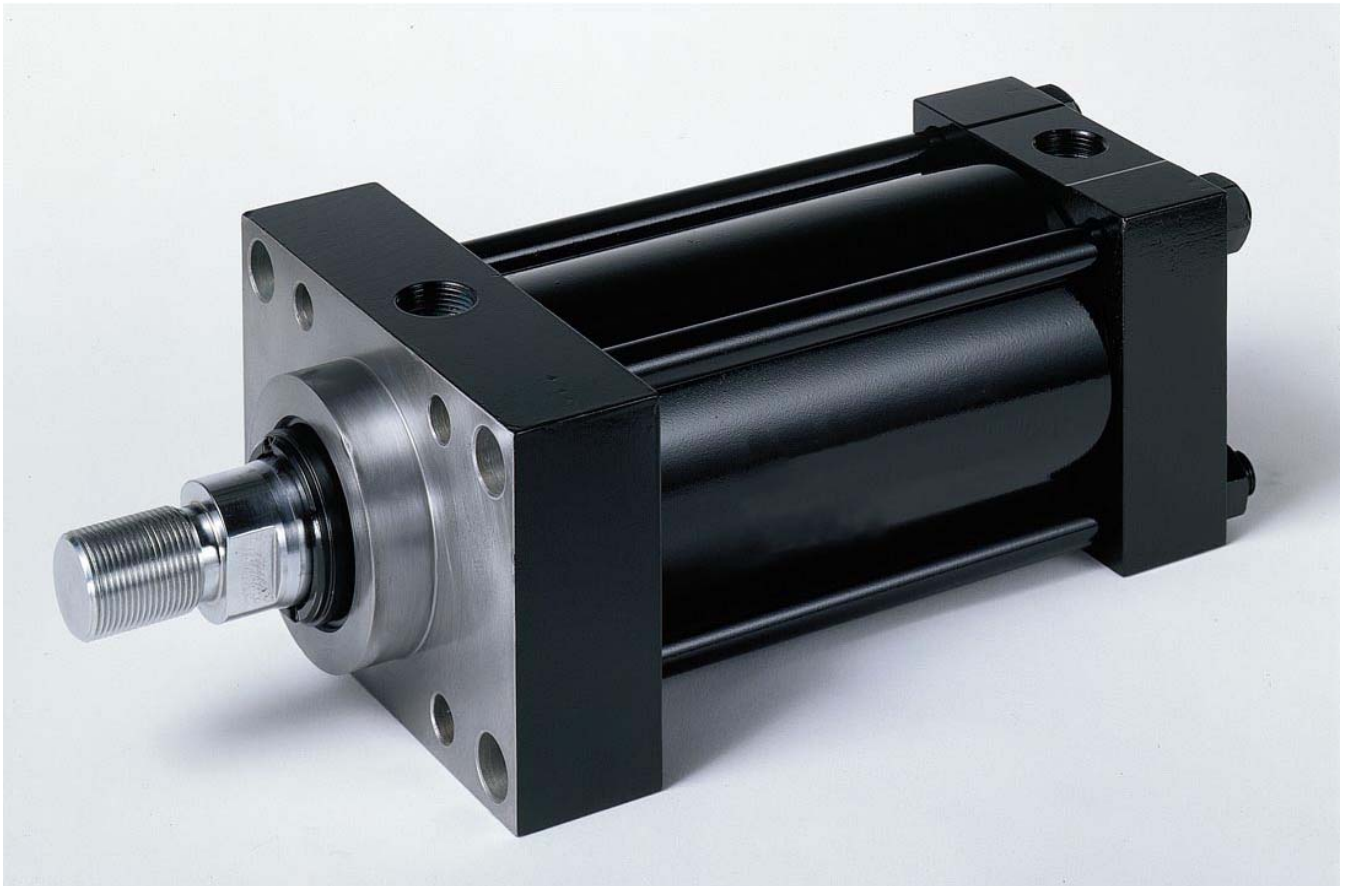

HYDRO-LINE



Product Features

Global Design:

Engineered for ISO 6020-2/DIN 24554 interchangeability with the durability required for heavy-duty applications.

Rod Cartridge Assembly:

Quick Change design requires no other cylinder disassembly for rod seal maintenance.

SureSeal™ Sealing System:

Carefully selected wiper and seal combinations are mated with a hard chrome plated piston rod to deliver exceptional all-around performance and durability.

Special Wearbands:

Metal-to-metal contact is eliminated, providing superior wearability, increased load carrying capability, and prolonged cylinder life.

Piston Sealing System:

This system offers not only a selection of highly efficient seal materials, but also an extra wide wearband that rides smoothly within the precision-honed cylinder body to provide extended piston seal life.

Square Head Tie-Rod Design:

Suitable for nominal pressure to 160 bar and working pressure up to 210 bar.

Full Range of Ports:

Including SAE, ISO 228-1 BSPP, and metric to ISO 6149 and DIN standard 3852 to provide the broadest piping flexibility.

Piston Rod:

Case hardened, hard chrome plated piston rod in a variety of diameters between 12 and 140 millimeters provides maximum durability and extends seal life. Several different rod end types are available.

ISO Standard Seal Grooves:

Rod and piston sealing systems both conform to ISO standard groove specifications.

Captive Screws:

Inadvertent removal of cushion screws and optional air bleed screws is prevented, while still allowing a full range of adjustment.

Bore Size Range:

Cylinder bores available between 25 and 200 millimeters.

Fully Adjustable

Cushioning System:

This design has been engineered to provide the ability to tune the cushion performance for an optimized deceleration profile. Our patented floating ring cushion seal or an alternate ball check design allows maximum acceleration. This excellent acceleration profile translates into faster cycle times and increased production.

Attention to Details:

One example is the careful design of the body-to-head joint. The design assures ease of assembly while maintaining tight tolerances for exceptional concentricity between cylinder parts.

Contents

Product Features	2
Specifications	4
How to Order	5
Mounting Styles	7
Mounting Style & Installation Dimensions	9
IHMA Side Lug Mounts	9
IHMAK Keyed Side Lug Mounts	10
DHMG Head Rectangular Mounts (DIN)	11
IHMG Head Rectangular Mounts (ISO)	12
IHMC Clevis Mount	13
IHMCS Spherical Bearing Mount	14
IHMP Cap Rectangular Mount	15
IHMTT Intermediate Trunnion Mount	16
IHMW Cap Trunnion Mount	17
IHMU Head Trunnion Mount	18
IHMN Cap Extended Tie Rod Mount	19
IHMM Head Extended Tie Rod Mount	20
IHML Both Ends Extended Tie Rod Mount	21
IHMAD Double Rod End, Side Lug Mount	22
IHMCE Cap Fixed Eye Mount	23
Accessories	24
Common Options Section	32
Application / Engineering Data	37
Cushion Data / Energy Absorbing Potential Charts	41
Weights	47
Design Options / Custom Products	48
Application Data Sheet	51

Specifications

Standard Features

- Captured cushion screws
- Oversized rods
- Standard BSPP, ISO, and SAE ports
- Wide rod end selection
- Piston with wear ring
- Double lip rod wiper
- Nonmetallic rod wearband
- Hardened rods

IHM Options

- ISO mounting styles
- Double rod end
- Air bleeders
- Gland drains
- Low friction seals
- High temperature seals
- Rod end couplers
- Proximity switches
- Adjustable cushions

Port and Cushion Adjustment Locations

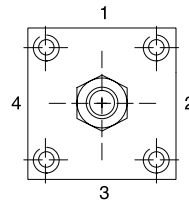

Standard port locations are at No. 1, with optional locations at No. 2, 3 or 4. Standard cushion adjustment location is in location No. 2 (code C), with optional locations at C1, C3 or C4.

Port Types and Sizes

A wide variety of standard ports are available in various sizes based on the bore size of the cylinder selected. The port options are available on pages 33 and 34.

IHM Special Modifications

- Special seals
- Nonstandard mount
- Oversize ports
- Bronze bushings
- Stainless steel rod
- Stop tube
- Nonrotating rod
- Rod boots
- Custom switches
- Studded rod ends
- Port or cushion modifications
- Double-end rod with different rod ends
- Special paint or finishes
- Linear displacement transducer
- Adjustable stroke
- Spring extend/return
- Electroless nickel plated

Specifications

Bore sizes: 25mm through 200mm
Pressure rating: 210 bar (3000 PSI) hydraulic
Temperature: -20°F to 400°F optional

ISO 6020-2 interchangeable mountings

IHM: Hydraulic cylinders incorporate exclusive SureSeal™ sealing system, which provides long life and superior leakage control. Black enamel paint is standard. Optional adjustable cushions feature retained adj. screws.

How To Order

Standard Cylinders

Eaton has created an easy system for ordering Series IHM Cylinders. This system has been developed to improve our service to you. The model code consists of sixteen alpha-numeric digits which fully describe the most common standard options offered on Series IHM cylinders.

To specify your Series IHM cylinder, review the following pages for a full description of each option available and select the desired code.

This model code system will:

- **Simplify the re-order process.**
Each Hydro-Line Series IHM cylinder is assigned a specific model code. That code is unique to a particular cylinder description. That way, when you re-order your Series IHM cylinder, you're assured of exactly the same top quality cylinder design.
- **Improve identification.**
Every Series IHM cylinder has its complete model code clearly marked on the product, impression stamped in a metal tag on head/cap. Each model code completely describes a specific cylinder. This allows seals and replacement components to be easily identified in the field.
- **Facilitate communications.**
This fully descriptive model code system allows you to work directly with your local Hydro-Line sales engineer to identify and service your Hydro-Line cylinder.

NOTE

See pages 6 and 7 for a summary of ISO 6020-2 model code options.

Custom Cylinders

New Cylinders

Although the model code has been arranged to cover the vast majority of available options, there will be occasions when you require an option which cannot be coded. When specifying such an option, enter an "X" for the appropriate item in the model code, then describe your requirements. For example, if you have an application which requires a custom thread on the end of the piston rod, enter an "X" for the rod end type. Then add a full description at the end of the model code, such as "With 80mm total rod projection and M22 x 1,5 thread 35mm long." The cylinder will then be given a unique design number on receipt of order (as explained below).

If more than one of custom option is required, enter an "X" in all the appropriate fields and describe in a suffix. The cylinder will then be given a unique design number on receipt of your order (as explained below).

Replacement Cylinders

Every Hydro-Line custom cylinder is assigned a unique design number. This number is contained in the final suffix of the digit model code. When ordering a replacement cylinder, simply give the complete model code or the design suffix to your local Hydro-Line Sales Representative.

Replacement Parts

Each design number is stored in a quick retrieval computerized storage system. This gives our field sales

representatives rapid access to assist you in identifying and specifying genuine Hydro-Line replacement parts.

How to Order an IHM Cylinder

Hydro-Line standard cylinders can be completely and accurately identified with a model number that encodes construction specifications. To develop the model number for ordering a cylinder, see the following example:

Feature	Description	Symbol	
Rod Diameter	Specify in millimetres	—	
Cushions	Non-cushioned	N	
	Cushioned both ends (insert locations 1-4)	B_	
	Cushioned head end (insert locations 1-4)	H_	
	Cushioned cap end (insert locations 1-5)	C_	
Stroke	Specify in millimetres	—	
Bore	Specify in millimetres	—	
Double Rod	Include ONLY for double-rod cylinder	D	
Mounting Style	Side lugs, MS2	A	
	Cap fixed clevis, MP1	C	
	Cap fixed eye, MP3	CE	
	Cap spherical bearing, MP5	CS	
	Head rectangular, ME5	G	
	No mount	K	
	All tie rods extended, MX1	L	
	Head end tie rods extended, MX3	M	
	Cap end tie rods extended, MX2	N	
	Cap rectangular, ME6	P	
	Intermediate fixed trunnion, MT4	TT	
	Head trunnion, MT1	U	
	Cap trunnion, MT2	W	
	Model/Series	ISO 6020/2 interchangeable	IHM
	Rod End Style	Style #2	2
Style #2M (male modified)*		2M	
Style #4		4	
Style #4M (female modified)*		4M	
Style #7		7	
Special*		M	
Ports	BSP/G (ISO 228/1) - (standard)	G	
	Metric (DIN 3852 form X)	D	
	Special	X	
Rod Seals	Urethane U-cup (standard)	H	
	Viton	F	
	Special	X	
Piston Seals	Radial seal with energizer (standard)	B	
	Low breakaway Teflon radial seal with wearband (standard)	T	
	Special	X	
Port Location-Head	Position #1	1	
	Position #2	2	
	Position #3	3	
	Position #4	4	
	Special	X	
Port Location-Cap	Position #1	1	
	Position #2	2	
	Position #3	3	
	Position #4	4	
	Position #5	5	
Special	X		
Special Modifications	Include ONLY if special modifications are required.		
	Air bleeders	Rod boots	
	Drainbacks	Indicator switches	
	Special seals	Four rod end flats	
	Non-std. mount	Port or cushion modifications	
	Oversize ports		
	Bronze bushings	Double-end rod with different rod ends	
	Key plate		
	SS rod	Special paint/plating	
	Stop tube	Linear displacement transducer	

HOW TO ORDER

- Quantity
- Model number
- Special modifications if required
- Completed Application Data Sheet(s) (page 9) if required.
- Required ship date



Eaton | Hydro-Line

IHMAD-80X100-N-36-
2-G-H-B-1-1-X
194011234-1
A11579-375

Customer Number (if desired)
Hydro-Line Serial Number

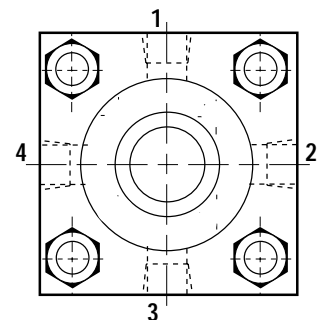

Port Locations

Port location #5 is on the center of the back face of the cap.

*Include drawing or description

IHM Series Mounting Application Data

Side Mounting

Side lugs mounted cylinders do not absorb force along their centerlines. The thrust of the cylinder is aligned parallel to, but not on, the centerline of the cylinder. For this reason side mounted cylinders produce a turning moment as the cylinder moves the load, this tends to rotate the cylinder about its mounting bolts. For this reason it is important that the cylinder is firmly secured to the mounting surface and the load is firmly guided to reduce side loading on the rod gland and piston. An extended key plate may be specified to provide positive cylinder location. Consult Eaton for details. If a side lugs mounted cylinder is required specify mounting style A. See page 9 for mounting dimensions.

Description	Hydro-Line Mount	ISO Designation
Side Lugs	A	MS2

End and Intermediate Pivot Mountings

Trunnion and clevis mounted cylinders allow the centerline of the cylinder to swing. These cylinders should be used when the actuated load travels through an arc. Trunnion and pivot pins are designed to carry shear loads only. Trunnion and pivot bearings must fit closely for the entire length of the pivot pin. Trunnion bearings should be held rigidly and be accurately aligned. If pivot mounted cylinders are required specify mounts C, CE, CS, U, W, or TT. See the appropriate pages for mounting dimensions.

Description	Hydro-Line Mount	ISO Designation
Cap Fixed Clevis	C	MP1
Cap Fixed Eye	CE	MP3
Cap Spherical Bearing	CS	MP5
Head Trunnion	U	MT1
Cap Trunnion	W	MT2
Intermediate Fixed Trunnion	TT	MT4

End Mountings

End mounted cylinders absorb force on the centerline of the cylinder and are suitable for straight line force transfer applications. These mounts allow the thrust or tension forces of the piston rod to be uniformly distributed about the cylinder centerline. If end mounted cylinders are required specify mounts L, N, M, G, or P. See pages 11 thru 22 for mounting dimensions. IHM series cylinders also satisfy all of the requirements of DIN 24 554 specifications.

Description	Hydro-Line Mount	ISO Designation
Tie Rods Extended	L, N, M	MX1, MX2, MX3
Head Rectangular	G	ME5 (does not meet DIN)
Cap Rectangular	P	ME6

Double Rod Cylinders

Double rod cylinders are available in all mountings except C, CE, CS, and W. Use the basic dimensional information on page 22 combined with dimensions in the other appropriate mounting drawings.

Mounting Accessories

See pages 24-31 for mounting accessories.

ISO Mounting Styles

IHMA
Side lug
ISO MS2

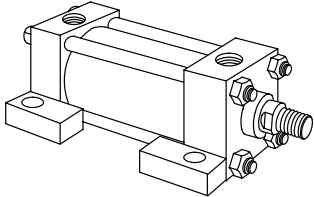

IHMAK
Keyed side lug

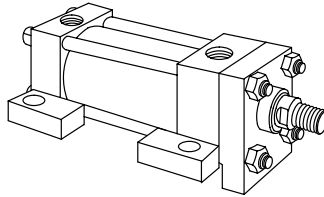

IHMG
Head rectangular
ISO ME5

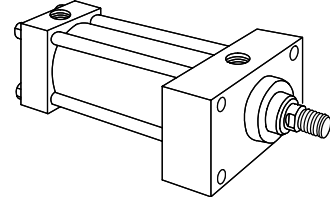

IHMC
Cap clevis
ISO MP1

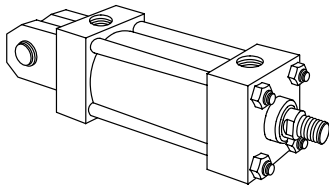

IHMCS
Spherical bearing
ISO MP5

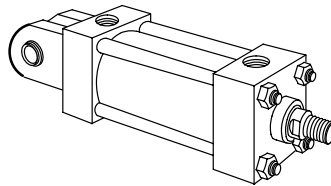

IHMP
Cap rectangular
ISO ME6

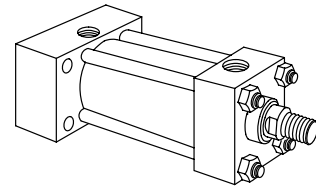

IHMTT
Intermediate trunnion
ISO MT4

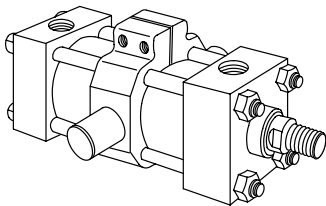

IHMW
Cap trunnion
ISO MT2

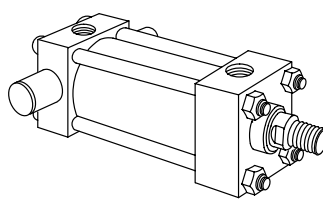

IHMU
Head trunnion
ISO MT1

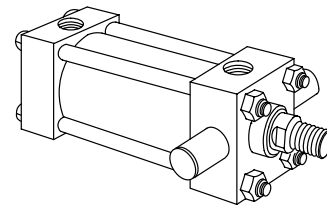

IHMN
Cap extended tie rod
ISO MX2

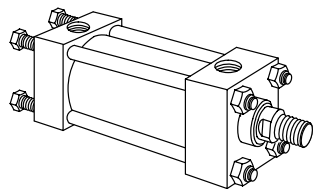

IHMM
Head extended tie rod
ISO MX3

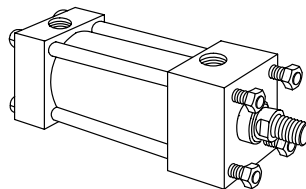

IHML
Both ends extended tie rod
ISO MX1

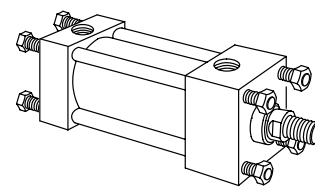

IHMAD
Double rod, side lug

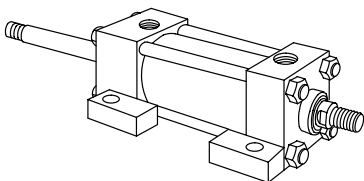

IHMCE
Cap fixed eye
ISO MP3

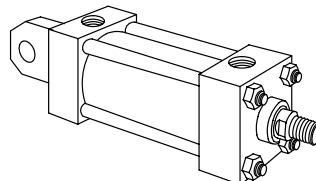

IHM Series Mounting Styles & Installation Dimensions

IHMA Side Lug Mounts

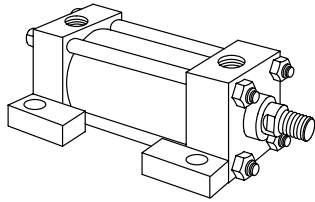

Side lug mounts are for moving loads along a flat guided surface as in a carriage along rails.

The mounting surface should be flat and parallel to the centerline of the piston rod. The load should be guided to

traverse along the centerline of the piston rod.

The frame on which the cylinder is mounted must be sufficiently rigid to resist bending moments.

NOTE

Limit operating pressure to 70 bar for minimum deflection. For strokes in excess of 600mm, see "Stop tube selection" on page 37.

With unsupported loads, the bearing must absorb more force. For these applications, the larger available rod is recommended, and stop tubes should be considered.

Use high tensile socket head cap screws or hex head bolts tightened to the manufacturer's recommended torque.

For high shock applications, dowel pins or shear keys should be incorporated in the mounting design. For these applications, consider a keyed side lug mount, IHMAK.

For severe side load applications, consult your local Hydro-Line sales engineer.

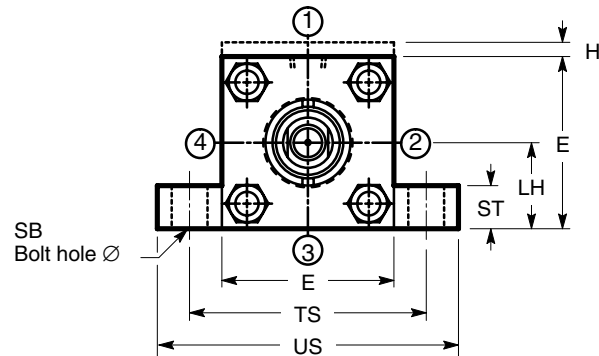
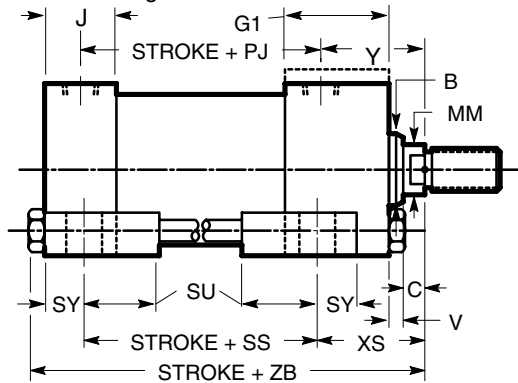

Bore	Rod MM	(f9) B	C	E	G1	H	J	V	Y	(h10) LH	PJ+	SB	SS+	ST	SU	SY	TS	US	XS	Max ZB+
25	12	24	10	40	50	5	25	6	50	19	53	6,6	73	9	19	8	54	72	33	121
	18	30	10	40	50	5	25	6	50	19	53	6,6	73	9	19	8	54	72	33	121
32	14	26	15	45	50	5	27	10	60	22	56	9	73	13	23	10	63	84	45	137
	22	34	17	45	50	5	27	9	60	22	56	9	73	13	23	10	63	84	45	137
40	18	30	20	63	57	-	38	6	62	31	73	11	98	13	23	10	83	103	45	166
	22	34	17					9												
50	22	34	17	75	60	-	38	9	67	37	74	14	92	19	33	12	102	127	54	176
	28	42	20					5												
63	28	42	27	90	60	-	38	5	71	44	80	18	86	26	40	17	124	161	65	185
	36	50	24					9												
80	36	50	26	115	69	-	44	5	77	57	93	18	105	26	40	17	149	186	68	212
	45	60	23					9												
100	45	60	30	130	73	-	44	5	82	63	101	26	102	32	51	22	172	216	79	225
	56	72	30					5												
125	56	72	27	165	80	-	57	9	86	82	117	26	131	32	51	22	210	254	79	260
	70	88	26					9												
160	70	88	26	205	88	-	57	7	86	101	130	33	130	38	63	29	260	318	86	279
	90	108	26					6												
200	90	108	26	245	107	-	76	6	98	122	165	39	172	44	73	35	311	381	92	336
	110	133	26					6												
	140	163																		

IHMAK Keyed Side Lug Mounts

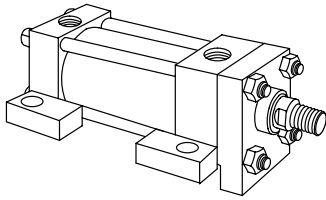

Keyed side lug mounts are for moving loads along a flat guided surface as in a carriage along rails.

The mounting surface should be flat and parallel to the centerline of the piston rod. The load should be guided to traverse along the centerline of the piston rod.

The frame on which the cylinder is mounted must be sufficiently rigid to resist bending moments.

NOTE

Limit operating pressure to 100 bar for minimum deflection. For strokes in excess of 600mm, see "Stop tube selection" on page 37.

With unsupported loads, the bearing must absorb more force. For these applications, the larger available rod is recommended, and stop tubes should be considered.

Use high tensile socket head cap screws or hex head bolts tightened to the manufacturer's recommended torque.

For severe side load applications, consult your local Hydro-Line sales engineer.

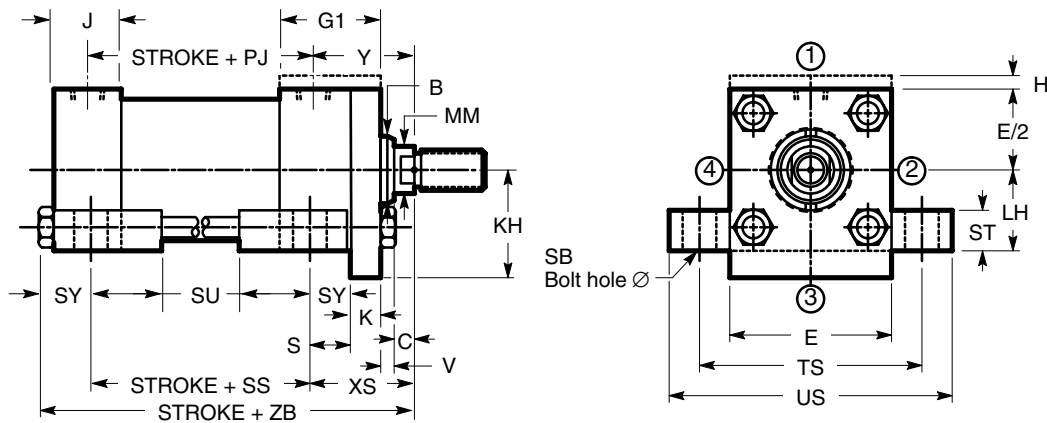

Bore	Rod MM	(f9) B	C	E	G1	H	J	K	S	V	Y	Max KH	(h10) LH	PJ+	SB	SS+	ST	SU	SY	TS	US	XS	Max ZB+
25	12	24	10	40	50	5	25	8	10	6	50	24	19	53	6,6	73	9	19	8	54	72	33	121
	18	30	10	40	50	5	25	8	10	6	50	24	19	53	6,6	73	9	19	8	54	72	33	121
32	14	26	15	45	50	5	27	8	12	10	60	27	22	56	9	73	13	23	10	63	84	45	137
	22	34	17	45	50	5	27	8	12	9	60	27	22	56	9	73	13	23	10	63	84	45	137
40	18	30	20	63	57	-	38	8	12	6	62	36	31	73	11	98	13	23	10	83	103	45	166
	22	34	17							9													
	28	42	14							12													
50	22	34	17	75	60	-	38	14	15	5	67	45	37	74	14	92	19	33	12	102	127	54	176
	28	42	20							9													
	36	50	17							9													
63	28	42	27	90	60	-	38	14	19	5	71	52	44	80	18	86	26	40	17	124	161	65	185
	36	50	24							9													
	45	60	20							12													
80	36	50	26	115	69	-	44	18	19	5	77	67	57	93	18	103	26	40	17	149	186	68	212
	45	60	23							9													
	56	72	23							9													
100	45	60	30	130	73	-	44	22	22	5	82	74	63	101	26	102	32	51	22	172	216	79	225
	56	72	30							5													
	70	88	26							9													
125	56	72	27	165	80	-	57	22	22	9	86	93	82	117	26	131	32	51	22	210	254	79	260
	70	88	26							9													
	90	108	26							9													
160	70	88	26	205	88	-	57	25	29	7	86	114	101	130	33	130	38	63	29	260	318	86	279
	90	108								6													
	110	133								6													
200	90	108	26	245	107	-	76	25	35	6	98	135	122	165	39	172	44	73	35	311	381	92	336
	110	133								6													
	140	163								6													

DHMG Head Rectangular Mounts (DIN ME5)

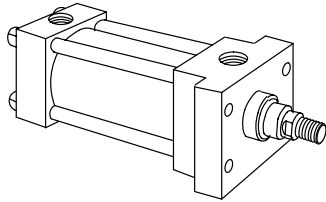

These mounts are ideal for straight line force transfer applications in which the cylinder is used in tension (pulling).

The mounting surface should be flat, and the rod end cartridge should be piloted into it.

The frame on which the cylinder is mounted must be sufficiently rigid to resist bending moments.

NOTE

For strokes in excess of 600mm, see "Stop tube selection" on page 37.

The force of the load should be perpendicular to the mounting surface

and parallel to the centerline of the piston rod. For eccentric loads, the larger of the two available rods in each bore size is recommended. Stop tubes should also be considered.

The head rectangular mounts (DHMG and IHMG) are recommended for heavy duty applications.

Use high tensile socket head cap screws or hex head bolts tightened to the manufacturer's recommended torque.

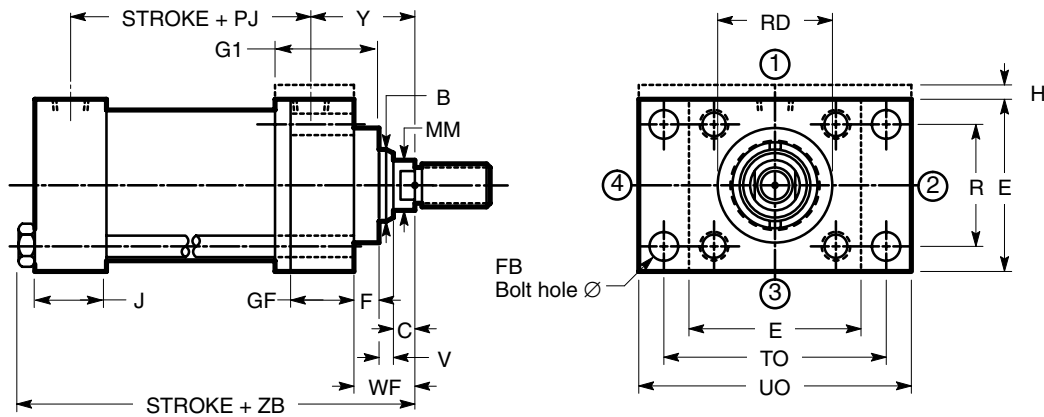

Bore	Rod MM	(f9) B	C	E	Max F	G1	GF	H	J	R	V	Y	FB	PJ+	(f8) RD	TO	Max UO	WF	Max ZB+
25	12	24	10	40	10	50	25	5	25	27	6	50	5,5	53	38	51	65	25	121
	18	30	10	40	10	50	25	5	25	27	6	50	5,5	53	38	51	65	25	121
32	14	26	15	45	10	50	25	5	27	33	10	60	6,6	56	42	58	70	35	137
	22	34	17	45	10	50	25	5	27	33	9	60	6,6	56	42	58	70	35	137
40	18	30	20	63	10	57	38	-	38	41	6	62	11	73	62	87	110	35	166
	22	34	17								9								
	28	42	14								12								
50	22	34	17	75	16	60	38	-	38	52	9	67	14	74	74	105	130	41	176
	28	42	20								5								
	36	50	17								9								
63	28	42	27	90	16	60	38	-	38	65	5	71	14	80	75	117	145	48	185
	36	50	24								9				82				
	45	60	20								12				88				
80	36	50	26	115	20	69	45	-	44	83	5	77	18	93	82	149	180	51	212
	45	60	23								9				92				
	56	72	23								9				105				
100	45	60	30	130	22	73	45	-	44	97	5	82	18	101	92	162	200	57	225
	56	72	30								5				105				
	70	88	26								9				125				
125	56	72	27	165	22	80	58	-	57	126	9	86	22	117	105	208	250	57	260
	70	88	26								9				125				
	90	108	26								9				150				
160	70	88	26	205	25	88	58	-	57	155	7	86	26	130	125	253	300	57	279
	90	108	26								6				150				
	110	133	26								6				170				
200	90	108	26	245	25	107	76	-	76	190	6	98	33	165	150	300	360	57	336
	110	133	26								6				170				
	140	163	26								6				210				

IHMG Head Rectangular Mounts (ISO ME5)

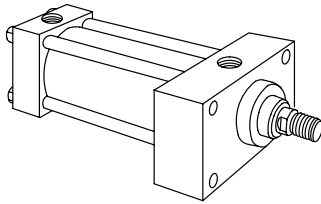

These mounts are ideal for straight line force transfer applications in which the cylinder is used in tension (pulling).

The mounting surface should be flat, and the rod end cartridge should be piloted into it.

The frame on which the cylinder is mounted must be sufficiently rigid to resist bending moments.

NOTE

For strokes in excess of 600mm, see "Stop tube selection" on page 37.

The force of the load should be perpendicular to the mounting surface

and parallel to the centerline of the piston rod. For eccentric loads, the larger of the two available rods in each bore size is recommended. Stop tubes should also be considered.

The head rectangular mounts (DHMG and IHMG) are recommended for heavy duty applications.

Use high tensile socket head cap screws or hex head bolts tightened to the manufacturer's recommended torque.

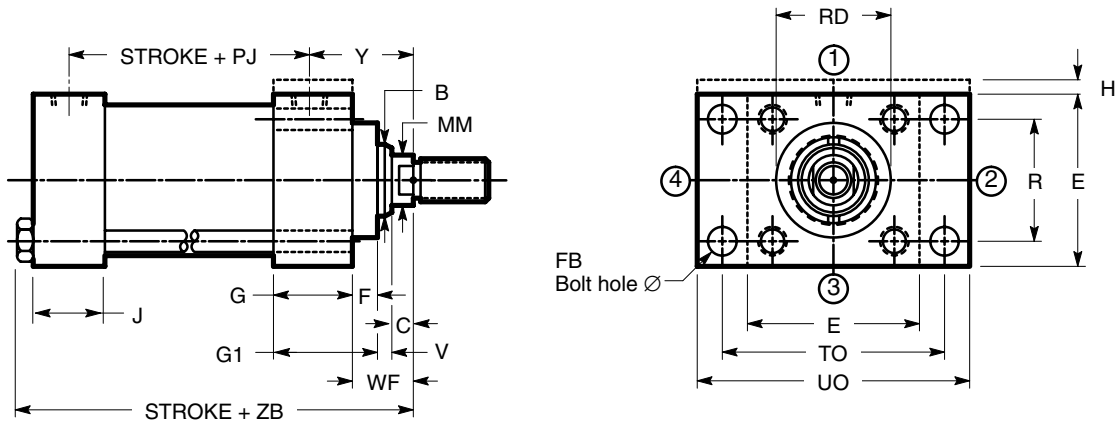

Bore	Rod MM	(f9) B	C	E	Max F	G	G1	H	J	R	V	Y	FB	PJ+	(f8) RD	TO	Max UO	WF	Max ZB+	
25	12	24	10	40	10	40	50	5	25	27	6	50	5,5	53	38	51	65	25	121	
	18	30	10	40	10	40	50	5	25	27	6	50	5,5	53	38	51	65	25	121	
32	14	26	15	45	10	40	50	5	27	33	10	60	6,6	56	42	58	70	35	137	
	22	34	17	45	10	40	50	5	27	33	9	60	6,6	56	42	58	70	35	137	
40	18	30	20	63	10	47	57	-	38	41	6	62	11	73	62	87	110	35	166	
	22	34	17								9									
	28	42	14								12									
50	22	34	17	75	16	44	60	-	38	52	9	67	14	74	74	105	130	41	176	
	28	42	20								5									
	36	50	17								9									
63	28	42	27	90	16	44	60	-	38	65	5	71	14	80	75	117	145	48	185	
	36	50	24								9				82					
	45	60	20								12				88					
80	36	50	26	115	20	49	69	-	44	83	5	77	18	93	82	149	180	51	212	
	45	60	23								9				92					
	56	72	23								9				105					
100	45	60	30	130	22	51	73	-	44	97	5	82	18	101	92	162	200	57	225	
	56	72	30								5				105					
	70	88	26								9				125					
125	56	72	27	165	22	58	80	-	57	126	9	86	22	117	105	208	250	57	260	
	70	88	26												105					125
	90	108	26												150					
160	70	88	26	205	25	58	88	-	57	155	7	86	26	130	125	253	300	57	279	
	90	108	26								6				150					
	110	133									6				170					
200	90	108	26	245	25	76	107	-	76	190	6	98	33	165	150	300	360	57	336	
	110	133	170																	
	140	163	210																	

IHMC Clevis Mount (ISO MP1)

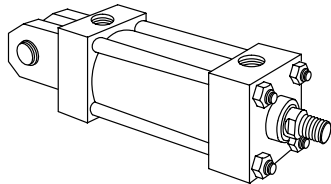

These mounts can be used both in compression (push) and tension (pull). Care must be exercised to prevent rod buckling in compression applications with long strokes. See page 39 for stroke limitations.

NOTE

For strokes in excess of 500mm, see "Stop tube selection" on page 37.

The centerline of the machine member that attaches to the swivel pin must be perpendicular to the centerline of the piston rod and the curved path must be in one plane only. Any misalignment will cause excess side loading on the bearing and piston. This will lead to premature failure. For applications with small amounts of misalignment, consider the spherical bearing mount, IHMCS.

These mounts are for applications in which the machine member travels in a curved path within one plane.

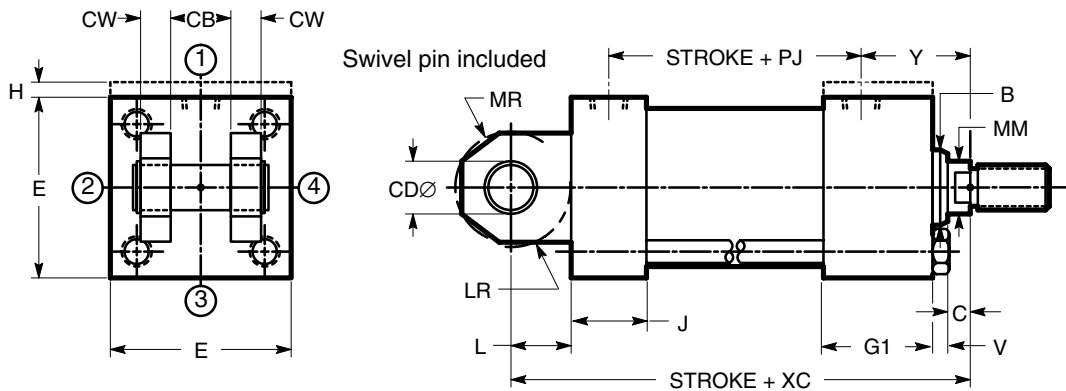

Bore	Rod MM	(f9) B	C	E	G1	H	J	Min L	V	Y	(A16) CB	(f8) CD	Max CW	Min LR	Max MR	PJ+	XC+
25	12	24	10	40	50	5	25	13	6	50	12	10	8,5	12	12	53	127
	18	30	10	40	50	5	25	13	6	50	12	10	8,5	12	12	53	127
32	14	26	15	45	50	5	27	19	10	60	16	12	10,5	17	17	56	147
	22	34	17	45	50	5	27	19	9	60	16	12	10,5	17	17	56	147
40	18	30	20	63	57	-	38	19	6	62	20	14	12,5	17	17	73	172
	22	34	17						9								
	28	42	14						12								
50	22	34	17	75	60	-	38	32	9	67	30	20	18	29	29	74	191
	28	42	20						5								
	36	50	17						9								
63	28	42	27	90	60	-	38	32	5	71	30	20	18	29	29	80	200
	36	50	24						9								
	45	60	20						12								
80	36	50	26	115	69	-	44	39	5	77	40	28	23,5	34	34	93	229
	45	60	23						9								
	56	72	23						9								
100	45	60	30	130	73	-	44	54	5	82	50	36	28,5	50	50	101	257
	56	72	30						5								
	70	88	26						9								
125	56	72	27	165	80	-	57	57	9	86	60	45	34,5	53	53	117	289
	70	88	26						9								
	90	108	26						9								
160	70	88	26	205	88	-	57	63	7	86	70	56	39,5	59	59	130	308
	90	108	26						6								
	110	133	26						6								
200	90	108	26	245	107	-	76	82	6	98	80	70	44,5	78	78	165	381
	110	133	26						6								
	140	163	26						6								

IHMCS Spherical Bearing Mount

(ISO MP5)

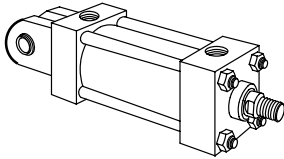

This mount is for applications in which the machine member travels in a curved path in one plane where some misalignment is unavoidable. The amount of allowable misalignment can be calculated.

This mount can be used both in compression (push) and tension (pull) applications. Care must be exercised to prevent rod buckling in compression

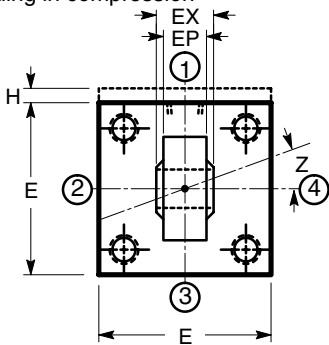

applications with long strokes. See page 39 for stroke limitations.

NOTE

For strokes in excess of 500mm, see "Stop tube selection" on page 37.

Maximum radial static and dynamic bearing loads must not exceed the recommended ratings shown in the following table.

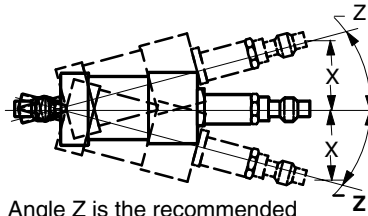

Angle Z is the recommended maximum angle of misalignment.

To find the maximum recommended X distance, multiply the distance between pivot mounting holes (see IHMCS dimensional drawing) by the tangent of angle Z.

Bore \varnothing (mm)	Mounting Hole \varnothing (mm)	Static Radial Load Rating (KN)
25	12	8
32	16	12,5
40	20	20
50	25	32
63	30	50
80	40	80
100	50	125
125	60	200
160	80	320
200	100	500

See page 31 for spherical rod end bearing accessory.

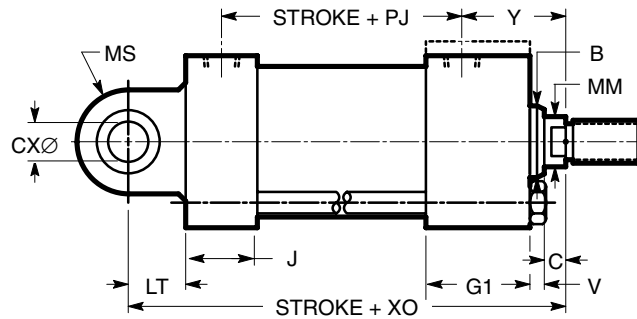

Bore	Rod MM	(f9) B	C	E	G1	H	J	V	Y	Min Z	CX	EP	EX	Min LT	Max MS	PJ+	XO+	
25	12	24	10	40	50	5	25	6	50	3°	12 +0,00/-0,008	8	10 +0,00/-0,12	16	20	53	130	
	18	30	10	40	50	5	25	6	50	3°	12 +0,00/-0,008	8	10 +0,00/-0,12	16	20	53	130	
32	14	26	15	45	50	5	27	10	60	3°	16 +0,00/-0,008	11	14 +0,00/-0,12	20	23	56	148	
	22	34	17	45	50	5	27	9	60	3°	16 +0,00/-0,008	11	14 +0,00/-0,12	20	23	56	148	
40	18	30	20	63	57	-	38	6	62	3°	20 +0,00/-0,012	13	16 +0,00/-0,12	25	29	73	178	
	22	34	17					9										
	28	42	14					12										
50	22	34	17	75	60	-	38	9	67	3°	25 +0,00/-0,012	17	20 +0,00/-0,12	31	33	74	190	
	28	42	20					5										
	36	50	17					9										
63	28	42	27	90	60	-	38	5	71	3°	30 +0,00/-0,012	19	22 +0,00/-0,12	38	40	80	206	
	36	50	24					9										
	45	60	20					12										
80	36	50	26	115	69	-	44	5	77	3°	40 +0,00/-0,012	23	28 +0,00/-0,12	48	50	93	238	
	45	60	23					9										
	56	72	23					9										
100	45	60	30	130	73	-	44	5	82	3°	50 +0,00/-0,012	30	35 +0,00/-0,12	58	62	101	261	
	56	72	30					5										
	70	88	26					9										
125	56	72	27	165	80	-	57	9	86	3°	60 +0,00/-0,015	38	44 +0,00/-0,15	72	80	117	304	
	70	88	26															-
	90	108	26															
160	70	88	26	205	88	-	57	7	86	3°	80 +0,00/-0,015	47	55 +0,00/-0,15	92	100	130	337	
	90	108						-										
	110	133																
200	90	108	26	245	107	-	76	6	98	3°	100 +0,00/-0,020	57	70 +0,00/-0,20	116	120	165	415	
	110	133																-
	140	163																

IHMP Cap Rectangular Mounts (ISO ME6)

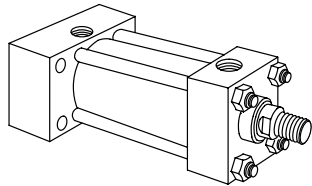

These mounts are for straight line force transfer applications in which the cylinder is used in compression (pushing) and tension (pulling) applications.

The mounting surface should be flat and perpendicular to the force of the load.

The frame on which the cylinder is mounted must be sufficiently rigid to resist bending moments.

The cap rectangular mount (IHMP) is recommended for heavy duty applications.

NOTE

For strokes in excess of 600mm, see "Stop tube selection" on page 37.

Use high tensile socket head cap screws or hex head bolts tightened to the manufacturer's recommended torque value.

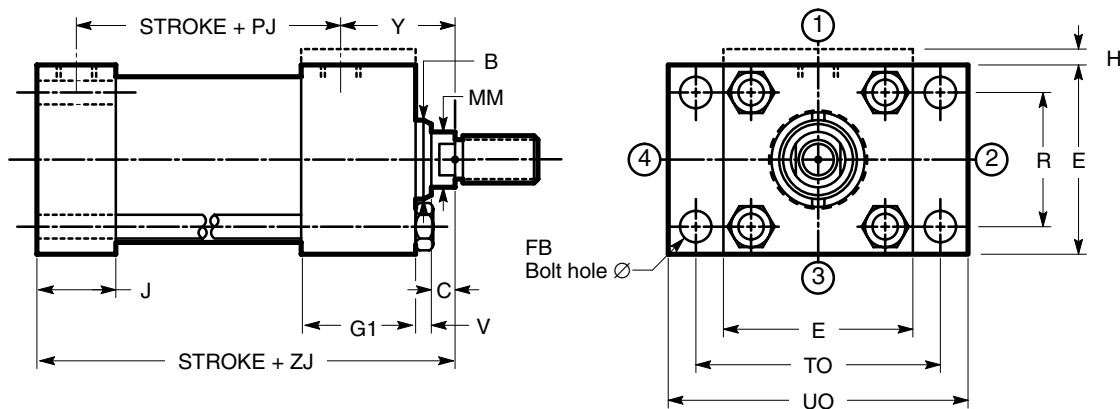

Bore	Rod MM	(f9) B	C	E	G1	H	J	R	V	Y	FB	PJ+	TO	Max UO	ZJ+
25	12	24	10	40	50	5	25	27	6	50	5,5	53	51	65	114
	18	30	10	40	50	5	25	27	6	50	5,5	53	51	65	114
32	14	26	15	45	50	5	27	33	10	60	6,6	56	58	70	128
	22	34	17	45	50	5	27	33	9	60	6,6	56	58	70	128
40	18	30	20	63	57	-	38	41	6	62	11	73	87	110	153
	22	34	17						9						
	28	42	14						12						
50	22	34	17	75	60	-	38	52	9	67	14	74	105	130	159
	28	42	20						5						
	36	50	17						9						
63	28	42	27	90	60	-	38	65	5	71	14	80	117	145	168
	36	50	24						9						
	45	60	20						12						
80	36	50	26	115	69	-	44	83	5	77	18	93	149	180	190
	45	60	23						9						
	56	72	23						9						
100	45	60	30	130	73	-	44	97	5	82	18	101	162	200	203
	56	72	30						5						
	70	88	26						9						
125	56	72	27	165	80	-	57	126	9	86	22	117	208	250	232
	70	88	26						9						
	90	108	26						9						
160	70	88	26	205	88	-	57	155	7	86	26	130	253	300	245
	90	108							6						
	110	133							6						
200	90	108	26	245	107	-	76	190	6	98	33	165	300	360	299
	110	133							6						
	140	163							6						

IHMTT Intermediate Trunnion Mount

(ISO MT4)

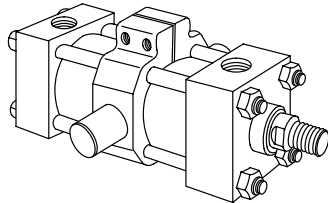

The Intermediate Trunnion Mount is for longer stroke applications in which the machine member travels in a curved path in one plane.

On special orders, the trunnion can be located anywhere along the body.

This mount can be used both in compression (push) and tension (pull) applications.

NOTE

For strokes in excess of 500mm, see "Stop tube selection" on page 37.

It is recommended that rigidly mounted pillow blocks with bearings at least as long as the trunnion pins be used. The pillow blocks should be installed as close to the shoulder of the trunnion as possible.

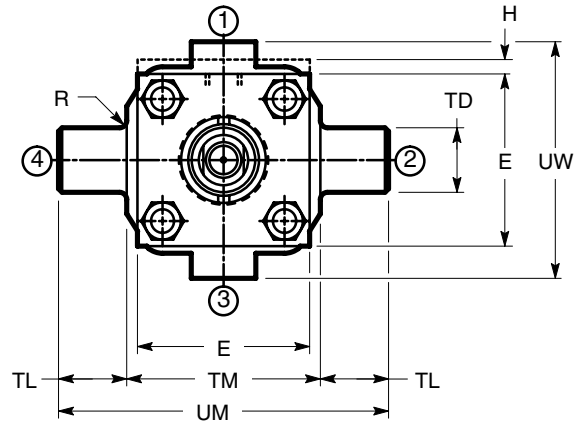
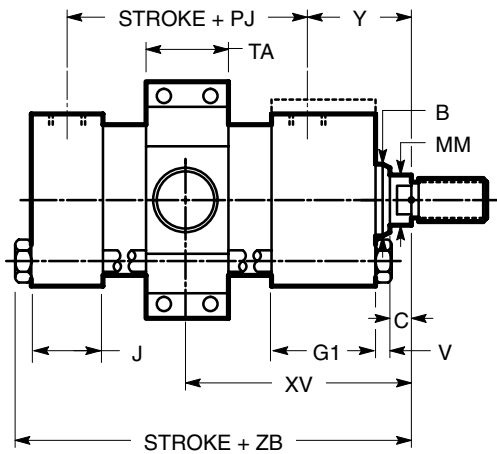

Bore	Rod MM	(f9) B	C	E	G1	H	J	R	V	Y	PJ+	TA	TD	TL	TM	UM	Max UW	Min	XV* Std*	Max+	Max ZB+
25	12	24	10	40	50	5	25	1,5	6	50	53	17,5	12 -0,016/-0,043	10	48	68	63	82	77	72	121
	18	30	10	40	50	5	25	1,5	6	50	53	17,5	12 -0,016/-0,043	10	48	68	63	82	77	72	121
32	14	26	15	45	50	5	27	1,5	10	60	56	20,0	16 -0,016/-0,043	12	55	79	75	96	89	82	137
	22	34	17	45	50	5	27	1,5	9	60	56	20,0	16 -0,016/-0,043	12	55	79	75	96	89	82	137
40	18	30	20	63	57	-	38	2,0	6	62	73	29,0	20 -0,020/-0,053	16	76	108	92	107	98	88	166
	22	34	17						9												
50	22	34	17	75	60	-	38	2,0	9	67	74	38,5	25 -0,020/-0,053	20	89	129	112	117	104	90	176
	28	42	20						5												
63	28	42	27	90	60	-	38	2,0	5	71	80	42,5	32 -0,025/-0,064	25	100	150	126	132	112	91	185
	36	50	24						9												
80	36	50	26	115	69	-	44	2,0	5	77	93	51,0	40 -0,025/-0,064	32	127	191	160	147	123	99	212
	45	60	23						9												
100	45	60	30	130	73	-	44	2,0	5	82	101	66,0	50 -0,025/-0,064	40	140	220	180	158	133	107	225
	56	72	30						5												
125	56	72	27	165	80	-	57	2,0	9	86	117	84,0	63 -0,030/-0,076	50	178	278	215	180	145	109	260
	70	88	26						7												
160	70	88	26	205	88	-	57	2,0	7	86	130	106	80 -0,030/-0,076	63	215	341	260	198	154	104	279
	90	108	26						6												
200	90	108	26	245	107	-	76	2,0	6	98	165	133	100 -0,036/-0,090	80	279	439	355	226	181	130	336
	110	133	26						6												

* The standard XV dimension is Stroke/2 + XV (std.) unless otherwise specified.
+ Plus stroke

IHMW Cap Trunnion Mounts (ISO MT2)

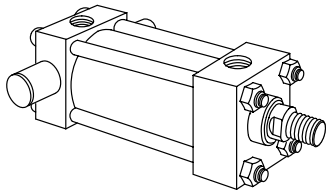

Either mount can be used both in compression (push) and tension (pull) applications. When used in compression applications, head trunnion mounts provide a longer maximum stroke than cap trunnion mounts.

NOTE

For strokes in excess of 500mm, see "Stop tube selection" on page 37.

an extremely tight fit to the mating machine member and permit curvilinear motion.

It is recommended that rigidly mounted pillow blocks with bearings at least as long as the trunnion pins be used. The pillow blocks should be installed as close to the shoulder of the trunnion as possible.

These mounts are for applications in which the machine member travels in a curved path in one plane.

The trunnion pins are an integral part of the head and can be sleeved to provide

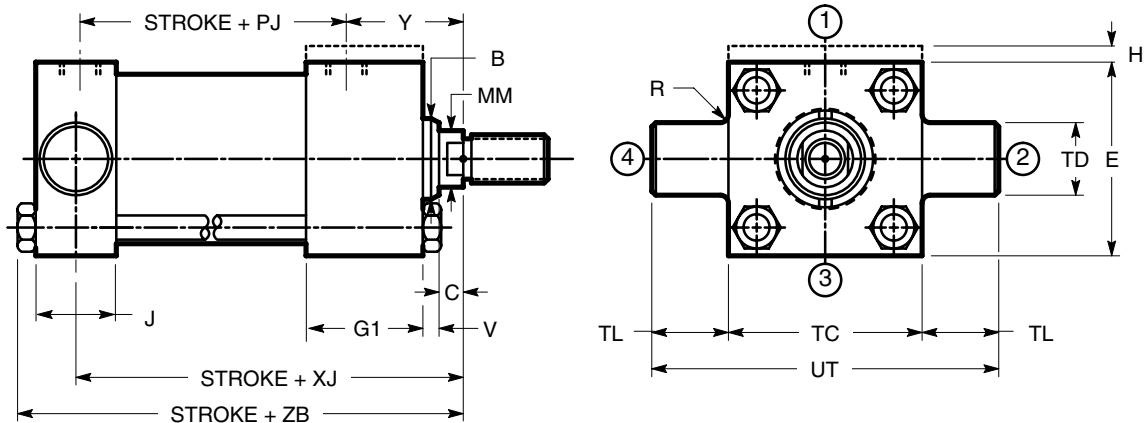

Bore	Rod MM	(f9) B	C	E	G1	H	J	Max R	V	Y	PJ+	(h14) TC	(f8) TD	TL	(h15) UT	XJ+	Max ZB+
25	12	24	10	40	50	5	25	1,1	6	50	53	38	12	10	58	101	121
	18	30	10	40	50	5	25	1,1	6	50	53	38	12	10	58	101	121
32	14	26	15	45	50	5	27	1,1	10	60	56	44	16	12	68	115	137
	22	34	17	45	50	5	27	1,1	9	60	56	44	16	12	68	115	137
40	18	30	20	63	57	-	38	1,1	6	62	73	63	20	16	95	134	166
	22	34	17						9								
	28	42	14						12								
50	22	34	17	75	60	-	38	1,1	9	67	74	76	25	20	116	140	176
	28	42	20						5								
	36	50	17						9								
63	28	42	27	90	60	-	38	1,9	5	71	80	89	32	25	139	149	185
	36	50	24						9								
	45	60	20						12								
80	36	50	26	115	69	-	44	1,9	5	77	93	114	40	32	178	168	212
	45	60	23						9								
	56	72	23						9								
100	45	60	30	130	73	-	57	1,9	5	82	101	127	50	40	207	187	235
	56	72	30						5								
	70	88	26						9								
125	56	72	27	165	80	-	70	1,9	9	86	117	165	63	50	265	209	270
	70	88	26						9								
	90	108	26						9								
160	70	88	26	205	88	-	89	1,9	7	86	130	203	80	63	329	230	305
	90	108							6								
	110	133							6								
200	90	108	26	245	107	-	108	1,9	6	98	165	241	100	80	401	276	360
	110	133							6								
	140	163							6								

IHMU Head Trunnion Mounts (ISO MT1)

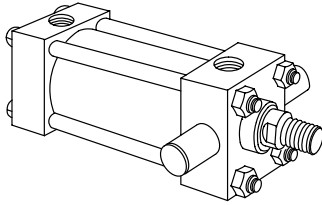

Either mount can be used both in compression (push) and tension (pull) applications. When used in compression applications, head trunnion mounts provide a longer maximum stroke than cap trunnion mounts.

NOTE

For strokes in excess of 500mm, see "Stop tube selection" on page 37.

an extremely tight fit to the mating machine member and permit curvilinear motion.

It is recommended that rigidly mounted pillow blocks with bearings at least as long as the trunnion pins be used. The pillow blocks should be installed as close to the shoulder of the trunnion as possible.

These mounts are for applications in which the machine member travels in a curved path in one plane.

The trunnion pins are an integral part of the head and can be sleeved to provide

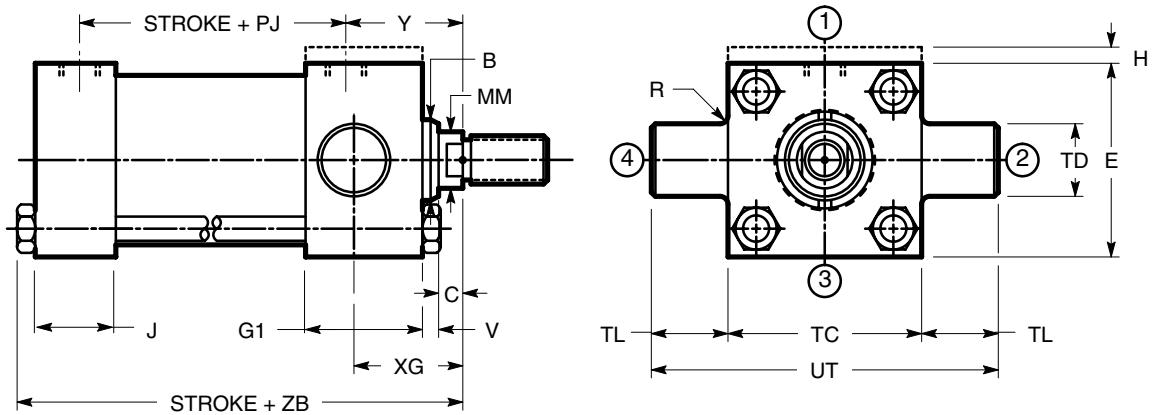

Bore	Rod MM	(f9) B	C	E	G1	H	J	Max R	V	Y	PJ+	(h14) TC	(f8) TD	TL	(h15) UT	XG	Max ZB+
25	12 18	24 30	10 10	40 40	50 50	5 5	25 25	1,1 1,1	6 6	50 50	53 53	38 38	12 12	10 10	58 58	44 44	121 121
32	14 22	26 34	15 17	45 45	50 50	5 5	27 27	1,1 1,1	10 9	60 60	56 56	44 44	16 16	12 12	68 68	54 54	137 137
40	18 22 28	30 34 42	20 17 14	63	57	— —	38	1,1	6 9 12	62	73	63	20	16	95	57	166
50	22 28 36	34 42 50	17 20 17	75	60	— —	38	1,1	9 5 9	67	74	76	25	20	116	64	176
63	28 36 45	42 50 60	27 24 20	90	60	— —	38	1,9	5 9 12	71	80	89	32	25	139	70	185
80	36 45 56	50 60 72	26 23 23	115	69	— —	44	1,9	5 9 9	77	93	114	40	32	178	76	212
100	45 56 70	60 72 88	30 30 26	130	73	— —	44	1,9	5 5 9	82	101	127	50	40	207	71	225
125	56 70 90	72 88 108	27 26 26	165	80	— —	57	1,9	9	86	117	165	63	50	265	75	260
160	70 90 110	88 108 133	26	205	88	— —	57	1,9	7 6 6	86	130	203	80	63	329	75	279
200	90 110 140	108 133 163	26	245	107	— —	76	1,9	6	98	165	241	100	80	401	85	336

IHMN Cap Extended Tie Rod Mounts (ISO MX2)

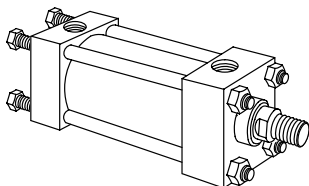

These mounts are for straight line force transfer applications. The cap extended tie rod mount is recommended for compression (pushing) applications.

The mounting surface should be flat and the frame on which the cylinder is mounted must be sufficiently rigid to resist bending moments.

Once fitted into the application framework, the nuts which are provided should be torqued to the values listed in the table (right).

NOTE

For strokes in excess of 600mm, see "Stop tube selection" on page 37.

Tie Rod Diameters & Torque Values

Diameters and torque values in the following table apply to all mounting styles.

Bore ∅ (mm)	Tie Rods ∅ (mm)	Torque* (Nm)
25	5	5,5
32	6	11
40	8	19
50	12	45
63	12	68
80	16	140
100	16	205
125	22	460
160	27	935
200	30	1520

* Recommended torque values using MoS₂ lubricant with 0,12 coefficient of friction.

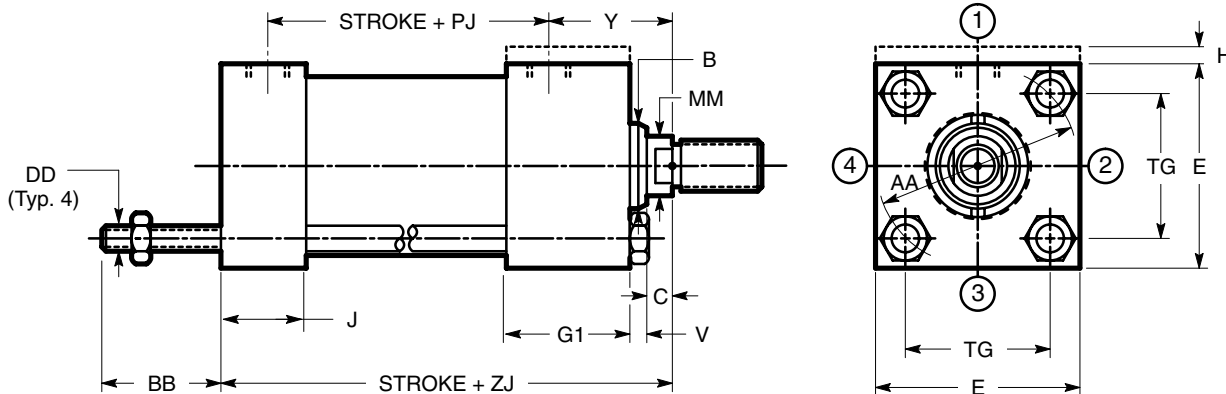

Bore	Rod MM	(f9) B	C	E	G1	H	J	V	Y	AA	BB	DD	PJ+	TG	ZJ+
25	12	24	10	40	50	5	25	6	50	40	19	M5 x 0,8	53	28,3	114
	18	30	10	40	50	5	25	6	50	40	19	M5 x 0,8	53	28,3	114
32	14	26	15	45	50	5	27	10	60	47	24	M6 x 1	56	33,2	128
	22	34	17	45	50	5	27	9	60	47	24	M6 x 1	56	33,2	128
40	18	30	20	63	57	-	38	6	62	59	35	M8 x 1	73	41,7	153
	22	34	17					9							
	28	42	14					12							
50	22	34	17	75	60	-	38	9	67	74	46	M12 x 1,25	74	52,3	159
	28	42	20					5							
	36	50	17					9							
63	28	42	27	90	60	-	38	5	71	91	46	M12 x 1,25	80	64,3	168
	36	50	24					9							
	45	60	20					12							
80	36	50	26	115	69	-	44	5	77	117	59	M16 x 1,5	93	82,7	190
	45	60	23					9							
	56	72	23					9							
100	45	60	30	130	73	-	44	5	82	137	59	M16 x 1,5	101	96,9	203
	56	72	30					5							
	70	88	26					9							
125	56	72	27	165	80	-	57	9	86	178	81	M22 x 1,5	117	125,9	232
	70	88	26					-							
	90	108	26												
160	70	88	26	205	88	-	57	7	86	219	92	M27 x 2	130	154,9	245
	90	108	-					6							
	110	133						6							
200	90	108	26	245	107	-	76	6	98	269	115	M30 x 2	165	190,2	299
	110	133	-												
	140	163													

IHMM Head Extended Tie Rod Mounts (ISO MX3)

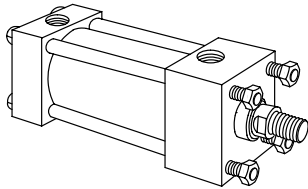

These mounts are for straight line force transfer applications. The head extended

tie rod mount is recommended for tension (pulling) applications.

The mounting surface should be flat and the frame on which the cylinder is mounted must be sufficiently rigid to resist bending moments.

On head mount applications, the cartridge provides a pilot diameter to align the rod in the mounting frame.

Once fitted into the application framework, the nuts which are provided should be torqued to the values listed in the table on the previous page.

NOTE

For strokes in excess of 600mm, see "Stop tube selection" on page 37.

The force on the rod should be perpendicular to the mounting surface and coincide with the centerline of the piston rod. For eccentric loads, the larger of the two available rods in each bore size is recommended. Stop tubes should also be considered.

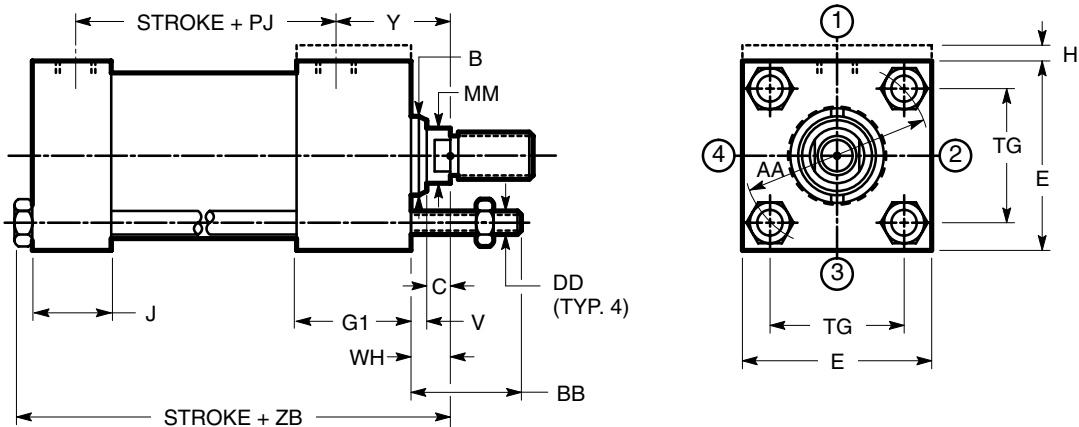

Bore	Rod MM	(f9) B	C	E	G1	H	J	V	Y	AA	BB	DD	PJ+	TG	WH	Max ZB+
25	12	24	10	40	50	5	25	6	50	40	19	M5 x 0,8	53	28,3	15	121
	18	30	10	40	50	5	25	6	50	40	19	M5 x 0,8	53	28,3	15	121
32	14	26	15	45	50	5	27	10	60	47	24	M6 x 1	56	33,2	25	137
	22	34	17	45	50	5	27	9	60	47	24	M6 x 1	56	33,2	25	137
40	18	30	20	63	57	-	38	6	62	59	35	M8 x 1	73	41,7	25	166
	22	34	9													
	28	42	12													
50	22	34	17	75	60	-	38	9	67	74	46	M12 x 1,25	74	52,3	25	176
	28	42	5													
	36	50	9													
63	28	42	27	90	60	-	38	5	71	91	46	M12 x 1,25	80	64,3	32	185
	36	50	9													
	45	60	12													
80	36	50	26	115	69	-	44	5	77	117	59	M16 x 1,5	93	82,7	31	212
	45	60	9													
	56	72	9													
100	45	60	30	130	73	-	44	5	82	137	59	M16 x 1,5	101	96,9	35	225
	56	72	5													
	70	88	9													
125	56	72	27	165	80	-	57	9	86	178	81	M22 x 1,5	117	125,9	35	260
	70	88	26													
	90	108	26													
160	70	88	26	205	88	-	57	7	86	219	92	M27 x 2	130	154,9	32	279
	90	108						6								
	110	133						6								
200	90	108	26	245	107	-	76	6	98	269	115	M30 x 2	165	190,2	32	336
	110	133														
	140	163														

IHML Both Ends Extended Tie Rod Mounts (ISO MX1)

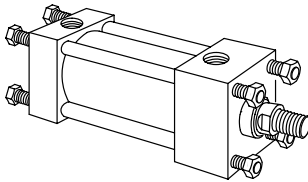

These mounts are for straight line force transfer applications. Both ends

extended tie rod mounts are suited for tension and compression applications or applications where additional hardware is to be attached to cylinders.

The mounting surface should be flat and the frame on which the cylinder is mounted must be sufficiently rigid to resist bending moments.

Once fitted into the application framework, the nuts which are provided should be torqued to the values listed in the table on page 19.

NOTE

For strokes in excess of 600mm, see "Stop tube selection" on page 37.

The force on the rod should be perpendicular to the mounting surface and coincide with the centerline of the piston rod. For eccentric loads, the larger of the two available rods in each bore size is recommended. Stop tubes should also be considered.

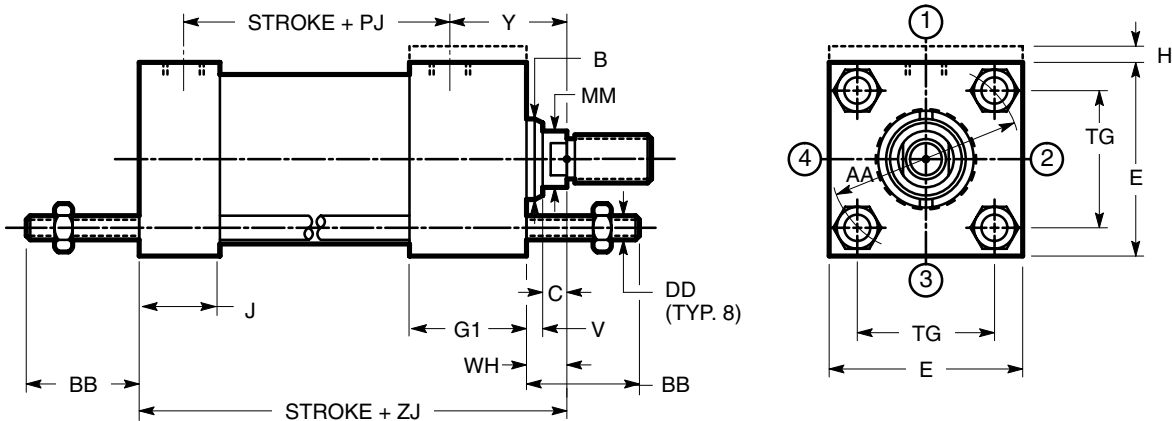

Bore	Rod MM	(f9) B	C	E	G1	H	J	V	Y	AA	BB	DD	PJ+	TG	WH	ZJ+
25	12 18	24 30	10 10	40 40	50 50	5 5	25 25	6 6	50 50	40 40	19 19	M5 x 0,8 M5 x 0,8	53 53	28,3 28,3	15 15	114 114
32	14 22	26 34	15 17	45 45	50 50	5 5	27 27	10 9	60 60	47 47	24 24	M6 x 1 M6 x 1	56 56	33,2 33,2	25 25	128 128
40	18 22 28	30 34 42	20 17 14	63	57	- - -	38	6 9 12	62	59	35	M8 x 1	73	41,7	25	153
50	22 28 36	34 42 50	17 20 17	75	60	- - -	38	9 5 9	67	74	46	M12 x 1,25	74	52,3	25	159
63	28 36 45	42 50 60	27 24 20	90	60	- - -	38	5 9 12	71	91	46	M12 x 1,25	80	64,3	32	168
80	36 45 56	50 60 72	26 23 23	115	69	- - -	44	5 9 9	77	117	59	M16 x 1,5	93	82,7	31	190
100	45 56 70	60 72 88	30 30 26	130	73	- - -	44	5 5 9	82	137	59	M16 x 1,5	101	96,9	35	203
125	56 70 90	72 88 108	27 26 26	165	80	- - -	57	9	86	178	81	M22 x 1,5	117	125,9	35	232
160	70 90 110	88 108 133	26	205	88	- - -	57	7 6 6	86	219	92	M27 x 2	130	154,9	32	245
200	90 110 140	108 133 163	26	245	107	- - -	76	6	98	269	115	M30 x 2	165	190,2	32	299

IHMAD Double Rod End, Side Lug Mounts (ISO MX1)

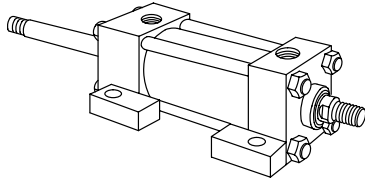

Double rod cylinders are specified when equal displacement is desired on both sides of the piston, or when the application is such that another function can be performed simultaneously with a second rod.

The single rod mount application data is also applicable to double rod cylinders.

NOTE

Limit operating pressure to 100 bar for minimum deflection.

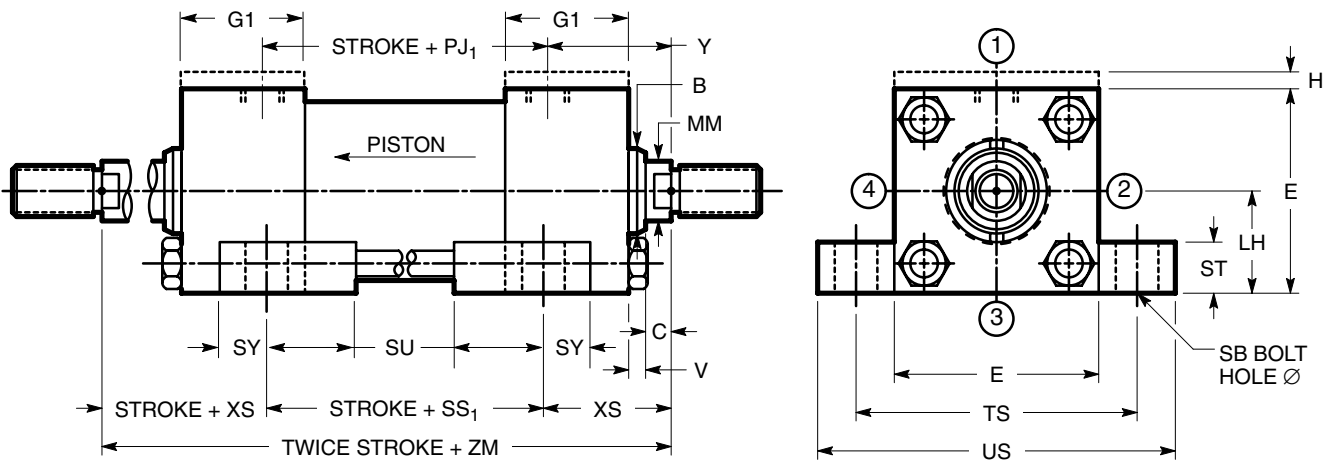

Bore	Rod MM	(f9) B	C	E	G1	H	V	Y	(h10) LH	PJ1+	SB	SS1+	ST	SU	SY	TS	US	XS	ZM++
25	12 18	24 30	10 10	40 40	50 50	5 5	6 6	50 50	19 19	51 51	6,6 6,6	85 85	9 9	19 19	8 8	54 54	72 72	33 33	151 151
32	14 22	26 34	15 17	45 45	50 50	5 5	10 9	60 60	22 22	56 56	9 9	86 86	13 13	23 23	10 10	63 63	84 84	45 45	176 176
40	18 22 28	30 34 42	20 17 14	63	57	- - -	6 9 12	62	31	69	11	103	13	23	10	83	103	45	193
50	22 28 36	34 42 50	17 20 17	75	60	- - -	9 5 9	67	37	72	14	98	19	33	12	102	127	54	206
63	28 36 45	42 50 60	27 24 20	90	60	- - -	5 9 12	71	44	81	18	93	26	40	17	124	161	65	223
80	36 45 56	50 60 72	26 23 23	115	69	- - -	5 9 9	77	57	92	18	110	26	40	17	149	186	68	246
100	45 56 70	60 72 88	30 30 26	130	73	- - -	5 5 9	82	63	103	26	109	32	51	22	172	216	79	268
125	56 70 90	72 88 108	27 26 26	165	80	- - -	9	86	82	114	26	128	32	51	22	210	254	79	286
160	70 90 110	88 108 133	26	205	88	- - -	7 6 6	86	101	137	33	137	38	63	29	260	318	86	309
200	90 110 140	108 133 163	26	245	107	- - -	6	98	122	160	39	172	44	73	35	311	381	92	356

+ Plus Stroke

++ Plus 2x Stroke

IHMCE Cap Fixed Eye Mount (ISO MP3)

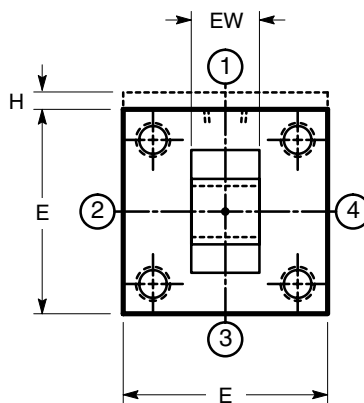
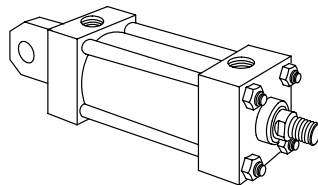

These mounts are for applications in which the machine member travels in a curved path within one plane.

These mounts can be used both in compression (push) and tension (pull). Care must be exercised to prevent rod buckling in compression applications with long strokes. See page 39 for stroke limitations.

NOTE

For strokes in excess of 500mm, see "Stop tube selection" on page 37.

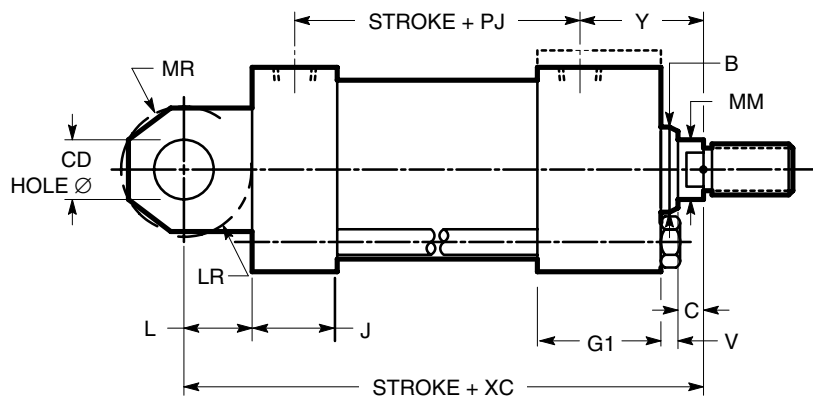

Bore	Rod MM	(f9) B	C	E	G1	H	J	L	V	Y	(h9) CD	EW	Min LR	Max MR	PJ+	XC+
25	12	24	10	40	50	5	25	13	6	50	10	12	12	12	53	127
	18	30	10	40	50	5	25	13	6	50	10	12	12	12	53	127
32	14	26	15	45	50	5	27	19	10	60	12	16	17	17	56	147
	22	34	17	45	50	5	27	19	9	60	12	16	17	17	56	147
40	18	30	20	63	57	—	38	19	6	62	14	20	17	17	73	172
	22	34	17						9							
	28	42	14						12							
50	22	34	17	75	60	—	38	32	9	67	20	30	29	29	74	191
	28	42	20						5							
	36	50	17						9							
63	28	42	27	90	60	—	38	32	5	71	20	30	29	29	80	200
	36	50	24						9							
	45	60	20						12							
80	36	50	26	115	69	—	44	39	5	77	28	40	34	34	93	229
	45	60	23						9							
	56	72	23						9							
100	45	60	30	130	73	—	44	54	5	82	36	50	50	50	101	257
	56	72	30						5							
	70	88	26						9							
125	56	72	27	165	80	—	57	57	9	86	45	60	53	53	117	289
	70	88	26						9							
	90	108	26						9							
160	70	88	26	205	88	—	57	63	7	86	56	70	59	59	130	308
	90	108							6							
	110	133							6							
200	90	108	26	245	107	—	76	82	6	98	70	80	78	78	165	381
	110	133							6							
	140	163							6							

Accessories

All rod accessories must be torqued against the rod shoulder.

Mounting brackets, rod clevises, and rod eyes for all IHM cylinders are available from Eaton. These accessories are detailed below showing part numbers and all pertinent dimensional data.

When ordering, please specify the part name and part number.

Plain Swivel Pin (Includes two retaining rings)

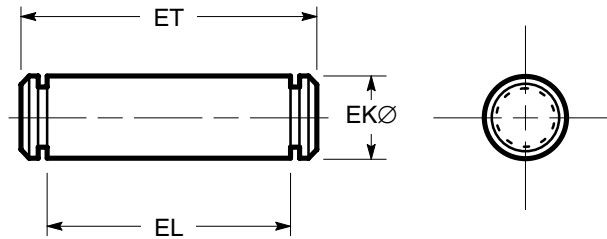

Part Number	EK	Min. EL	Max. ET	Maximum Load		Weight (kg)
				(kN)	(lbs)	
CH-9025-3	10 ^{-0,013/-0,035}	29	37,6	8	1800	0,023
CH-9032-3	12 ^{-0,016/-0,043}	37	45,6	12,5	2800	0,040
CH-9040-3	14 ^{-0,016/-0,043}	45	53,4	20	4500	0,061
CH-9050-3	20 ^{-0,020/-0,053}	66	75,2	50	11250	0,182
CH-9080-3	28 ^{-0,020/-0,053}	87	96,9	80	18000	0,407
CH-90100-3	36 ^{-0,025/-0,064}	107	120,5	125	28100	0,930
CH-90125-3	45 ^{-0,025/-0,064}	129	144,0	200	45000	1,635
CH-90160-3	56 ^{-0,030/-0,076}	149	164,6	320	72000	3,100
CH-90200-3	70 ^{-0,030/-0,076}	169	187,4	500	112400	5,390

Plain Rod Eye

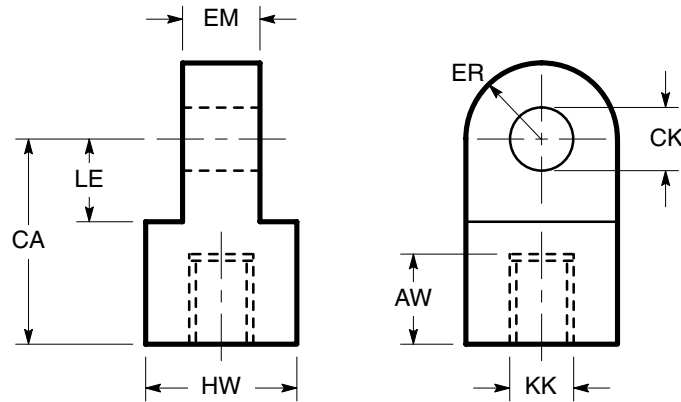

Part Number	Bore Ø	Min. AW	CA (js13)	CK (H9)	+0,00 EM (h13)	Max. ER
CH-9310	25	14	32 ±0,20	10 +0,036/-0,000	12 -0,27	12
CH-9312	32	16	36 ±0,20	12 +0,043/-0,000	16 -0,27	17
CH-9314	40	18	38 ±0,20	14 +0,043/-0,000	20 -0,33	17
CH-9316	50	22	54 ±0,23	20 +0,052/-0,000	30 -0,33	29
CH-9320	63	28	60 ±0,23	20 +0,052/-0,000	30 -0,33	29
CH-9327	80	36	75 ±0,23	28 +0,052/-0,000	40 -0,39	34
CH-9333	100	45	99 ±0,27	36 +0,062/-0,000	50 -0,39	50
CH-9342	125	56	113 ±0,27	45 +0,062/-0,000	60 -0,46	53
CH-9348	160	63	126 ±0,32	56 +0,074/-0,000	70 -0,46	59
CH-9364	200	85	168 ±0,32	70 +0,074/-0,000	80 -0,46	78

Part Number	Bore Ø	HW	KK*	Min. LE	Nominal Force	
					(kN)	(lbs)
CH-9310	25	18	M10 x 1,25	13	8	1800
CH-9312	32	22	M12 x 1,25	19	12,5	2800
CH-9314	40	20	M14 x 1,5	19	20	4500
CH-9316	50	30	M16 x 1,5	32	32	7200
CH-9320	63	33	M20 x 1,5	32	50	11250
CH-9327	80	40	M27 x 2	39	80	18000
CH-9333	100	50	M33 x 2	54	125	26100
CH-9342	125	65	M42 x 2	57	200	45000
CH-9348	160	90	M48 x 2	63	320	72000
CH-9364	200	110	M64 x 3	83	500	112400

* Proper rod end type must be selected.

Accessories

Spherical Bearing Clevis Bracket (per DIN 24556 / ISO 8133)

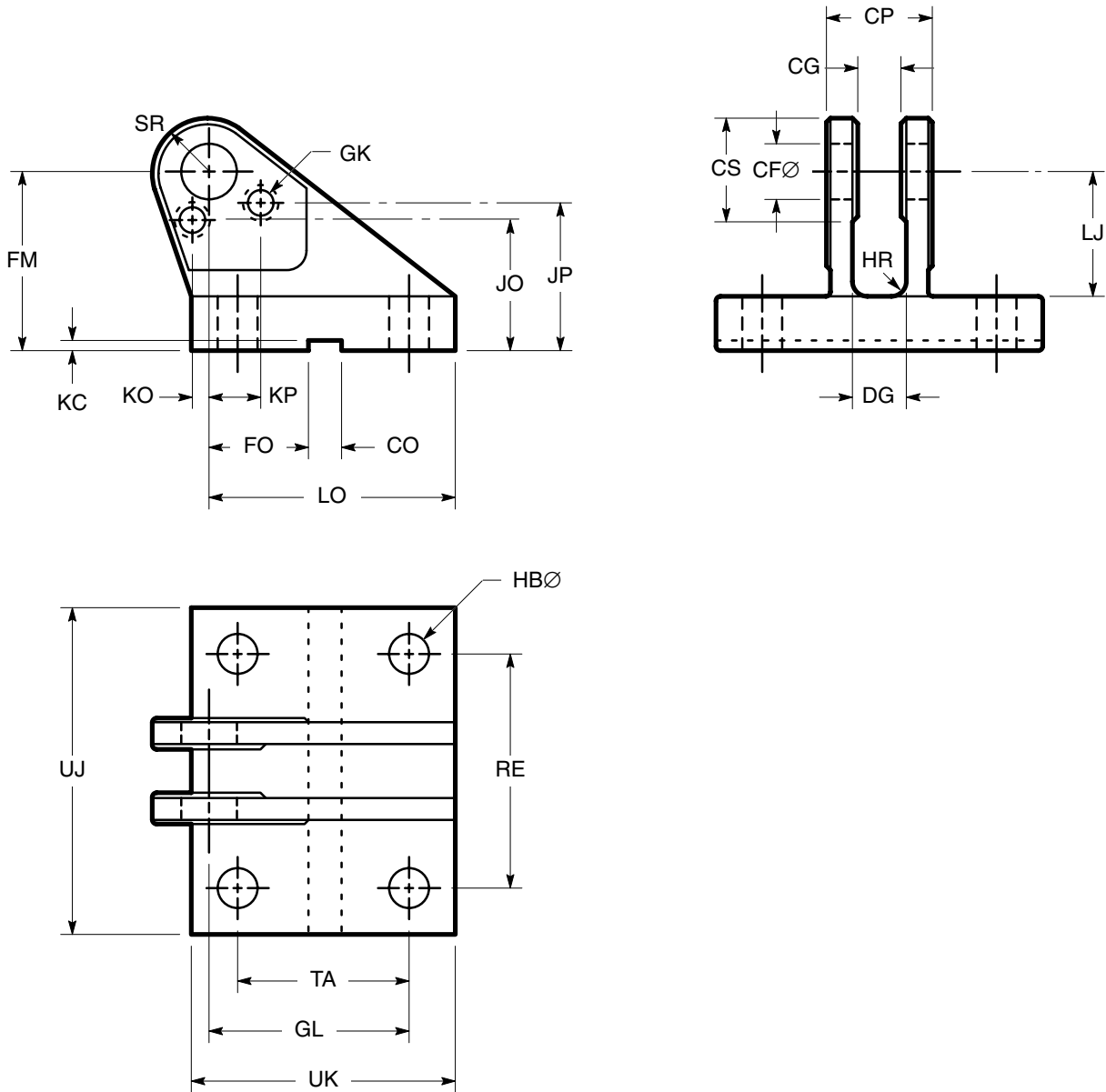

Part Number	CF (K7)	+0,3/+0,1 CG	+0,00 CO (N9)	CP (h14)	Max. CS	+2/-0 DG	FM (js11)	FO (js14)
CSH-133-25	12 +0,006/-0,012	10	10 -0,036	30 +0,00/-0,62	16	12	40 ±0,08	16 ±0,215
CSH-133-32	16 +0,006/-0,012	14	16 -0,043	40 +0,00/-0,62	22	16	50 ±0,10	18 ±0,26
CSH-133-40	20 +0,006/-0,015	16	16 -0,043	50 +0,00/-0,74	25	19	55 ±0,10	20 ±0,26
CSH-133-50	25 +0,006/-0,015	20	25 -0,052	60 +0,00/-0,74	30	24	65 ±0,10	22 ±0,26
CSH-133-63	30 +0,006/-0,015	22	25 -0,052	70 +0,00/-0,74	35	26	85 ±0,11	24 ±0,26
CSH-133-80	40 +0,007/-0,018	28	36 -0,062	80 +0,00/-0,87	47	32	100 ±0,11	24 ±0,26
CSH-133-100	50 +0,007/-0,018	35	36 -0,062	100 +0,00/-0,87	58	41	125 ±0,13	35 ±0,31
CSH-133-125	60 +0,009/-0,021	44	50 -0,062	120 +0,00/-1,00	68	50	150 ±0,13	35 ±0,31
CSH-133-160	80 +0,009/-0,021	55	50 -0,062	160 +0,00/-1,00	90	65	190 ±0,15	35 ±0,31
CSH-133-200	100 +0,010/-0,025	70	63 -0,074	200 +0,00/-1,15	111	80	210 ±0,15	35 ±0,31

Part Number	GK	GL (js13)	HB	HR	±0,2 JO	±0,2 JP	+0,30/-0,00 KC	±0,2 KO	±0,2 KP	LJ
CSH-133-25	M6	46 ±0,20	9	3	29,1	33,2	3,3	3,9	11,6	29
CSH-133-32	M6	61 ±0,23	11	3	36,7	42,2	4,3	5,2	18,9	38
CSH-133-40	M6	64 ±0,23	14	3	38,3	44,7	4,3	8,5	15,6	40
CSH-133-50	M6	78 ±0,23	16	4	48,5	48,5	5,4	11	14	49
CSH-133-63	M6	97 ±0,27	18	4	66	66	5,4	15	15	63
CSH-133-80	M8	123 ±0,32	22	4	77	77	8,4	21	21	73
CSH-133-100	M8	155 ±0,32	30	6	95,5	95,5	8,4	22,5	22,5	92
CSH-133-125	M10	187 ±0,36	39	6	116,5	116,5	11,4	27,5	27,5	110
CSH-133-160	M10	255 ±0,41	45	6	146	146	11,4	30	30	142
CSH-133-200	M10	285 ±0,41	48	6	154	154	12,4	45	45	152

Part Number	LO	RE (js13)	Max. SR	TA (js13)	UJ	UK	Max. Load (kN)	(lbs)	Weight (kg)	(lbs)
CSH-133-25	56	55 ±0,23	12	40 ±0,20	75	60	8	1800	0,52	1,15
CSH-133-32	74	70 ±0,23	16	55 ±0,23	95	80	12,5	2800	1,05	2,31
CSH-133-40	80	85 ±0,27	20	58 ±0,23	120	90	20	4500	1,72	3,79
CSH-133-50	98	100 ±0,27	25	70 ±0,23	140	110	32	7200	2,72	6,00
CSH-133-63	120	115 ±0,27	30	90 ±0,27	160	135	50	11250	5,15	11,35
CSH-133-80	148	135 ±0,32	40	120 ±0,32	190	170	80	18000	9,30	20,50
CSH-133-100	190	170 ±0,32	50	145 ±0,32	240	215	125	26100	18,3	40,3
CSH-133-125	225	200 ±0,36	60	185 ±0,36	270	260	200	45000	35,0	77,2
CSH-133-160	295	240 ±0,36	80	260 ±0,41	320	340	320	72000	63,0	138,9
CSH-133-200	335	300 ±0,41	100	300 ±0,41	400	400	500	112400	109,0	240,3

Accessories

Swivel Pin for Spherical Bearing with Retaining Rings

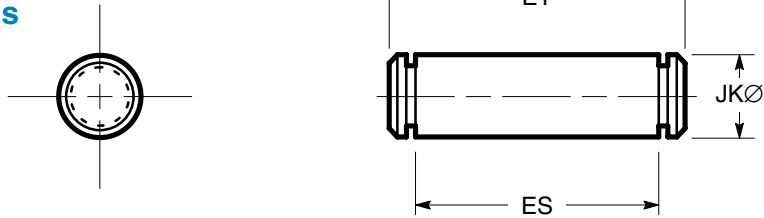

Part Number	JK		Max. ET	Min. ES	Max. Load		Weight (kg)
					(kN)	(lbs)	
CSH-90-25	12	+0,000/-0,011	39,6	31	8	1800	0,035
CSH-90-32	16	+0,000/-0,011	49,6	41	12,5	2800	0,075
CSH-90-40	20	+0,000/-0,013	60,2	51	20	4500	0,145
CSH-90-50	25	+0,000/-0,013	70,2	61	32	7200	0,260
CSH-90-63	30	+0,000/-0,013	80,8	71	50	11250	0,380
CSH-90-80	40	+0,000/-0,016	94,5	81	80	18000	0,895
CSH-90-100	50	+0,000/-0,016	116,5	101	125	26100	1,630
CSH-90-125	60	+0,000/-0,019	136,6	121	200	45000	2,950
CSH-90-160	80	+0,000/-0,019	179,2	161	320	72000	6,730
CSH-90-200	100	+0,000/-0,022	220,4	201	500	112400	13,500

Swivel Pin for Spherical Bearing with Locking Plate

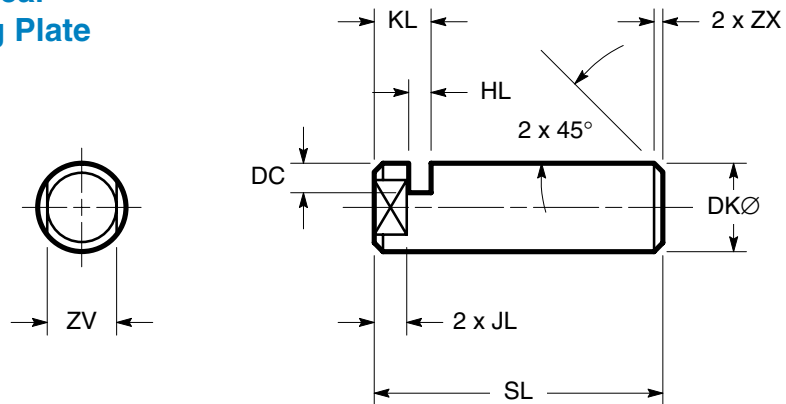

Part Number	^{+0,00} DK (h6)	DC	^{+0,2/-0,0} HL	JL	KL	SL	ZV	ZX	Max. Load		Weight (kg)
									(kN)	(lbs)	
CSHB-90-25	12 _{-0,011}	4	3,3	4,5	8	40	10	1	8	1800	0,035
CSHB-90-32	16 _{-0,011}	4	3,3	5,5	8	50	13	1	12,5	2800	0,075
CSHB-90-40	20 _{-0,013}	5	4,5	5,5	10	62	17	1,5	20	4500	0,150
CSHB-90-50	25 _{-0,013}	5	4,5	5,5	10	72	22	1,5	32	7200	0,270
CSHB-90-63	30 _{-0,013}	6	5,5	7,5	13	85	24	2	50	11250	0,410
CSHB-90-80	40 _{-0,016}	7	6,5	9,5	16	100	32	2	80	18000	0,950
CSHB-90-100	50 _{-0,019}	8	9,0	10,0	19	122	41	2	125	26100	1,710
CSHB-90-125	60 _{-0,019}	9	9,0	11,0	20	145	50	2	200	45000	3,130
CSHB-90-160	80 _{-0,019}	11	11,0	15,0	26	190	70	3	320	72000	7,140
CSHB-90-200	100 _{-0,021}	14	13,0	15,0	30	235	90	3	500	112400	14,400

Locking Plate for Swivel Pin

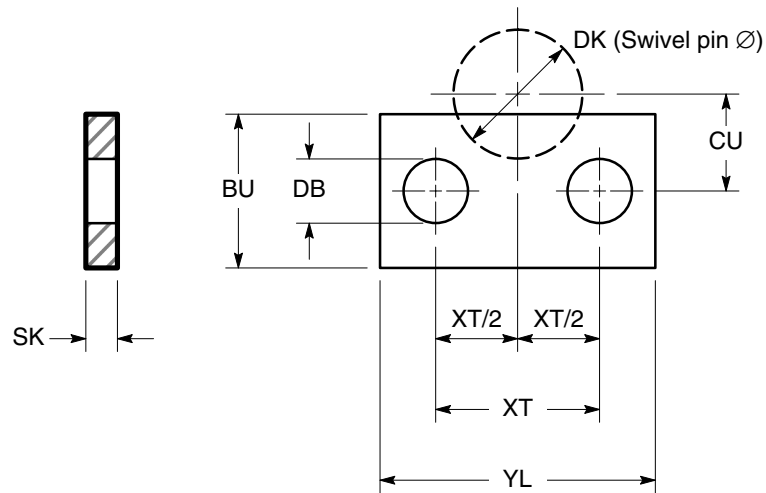

Part Number	DK	BU	DB	SK	YL	$\pm 0,2$ XT	Ref. CU	(2 included) Screw	Weight (kg)
7959-012	12	15	6,4	3	27	16	9,5	M6 x 12	0,015
7959-016	16	15	6,4	3	40	25	11,5	M6 x 12	0,020
7959-020	20	18	6,4	4	40	25	14,5	M6 x 15	0,032
7959-025	25	18	6,4	4	40	25	16,5	M6 x 15	0,032
7959-030	30	20	6,4	5	45	30	19,0	M6 x 15	0,050
7959-040	40	20	8,4	6	62	42	23,0	M8 x 20	0,078
7959-050	50	25	8,4	8	65	45	29,5	M8 x 20	0,090
7959-060	60	25	10,5	8	80	55	33,5	M10 x 25	0,170
7959-080	80	30	10,5	10	90	60	44,0	M10 x 25	0,250
7959-100	100	40	10,5	12	120	90	56,0	M10 x 25	0,490

Accessories

Selecting Accessories

Rod end accessories are selected by the corresponding rod end threads. Cap end accessories are selected by cylinder bore size. Reference the following tables.

Rod End Accessory Combinations

Thread KK	Plain Rod Clevis	Eye Bracket	Plain Pivot Pin
M10 x 1,25	CH-134-10	CH-8925	CH-9025-3
M12 x 1,25	CH-134-12	CH-8932	CH-9032-3
M14 x 1,5	CH-134-14	CH-8940	CH-9040-3
M16 x 1,5	CH-134-16	CH-8950	CH-9050-3
M20 x 1,5	CH-134-20	CH-8963	CH-9050-3
M27 x 2	CH-134-27	CH-8980	CH-9080-3
M33 x 2	CH-134-33	CH-89100	CH-90100-3
M42 x 2	CH-134-42	CH-89125	CH-90125-3
M48 x 2	CH-134-48	CH-89160	CH-90160-3
M64 x 3	CH-134-64	CH-89200	CH-90200-3

Cap End Mounting – Eye Bracket for IHMC Mount

Bore Diameter (mm)	Eye Bracket
25	CH-8925
32	CH-8932
40	CH-8940
50	CH-8950
63	CH-8963
80	CH-8980
100	CH-89100
125	CH-89125
160	CH-89160
200	CH-89200

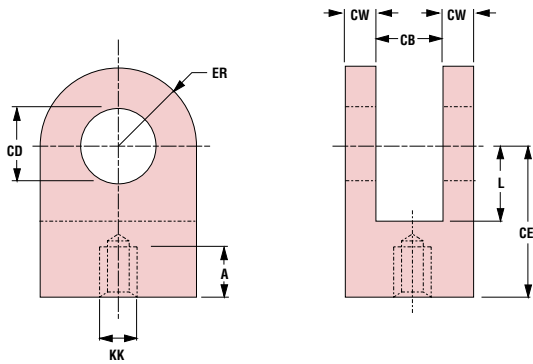

Plain Rod Clevis

Part No.	A _{min}	CD	CB _{max}	CE	CW	ER _{max}	KK	L _{min}
CH-134-10	14	10	12	32	7	12	M10 x 1,25	13
CH-134-12	16	12	16	36	9	17	M12 x 1,25	19
CH-134-14	18	14	20	38	11	17	M14 x 1,5	19
CH-134-16	22	20	30	54	16	29	M16 x 1,5	32
CH-134-20	28	20	30	60	16	29	M20 x 1,5	32
CH-134-27	36	28	40	75	21,5	34	M27 x 2	39
CH-134-33	45	36	50	99	26,5	50	M33 x 2	54
CH-134-42	56	45	60	113	31,5	53	M42 x 2	57
CH-134-48	63	56	70	126	36,5	59	M48 x 2	63
CH-134-64	85	70	80	168	41,5	78	M64 x 3	83

All dimensions in millimetres unless otherwise stated.

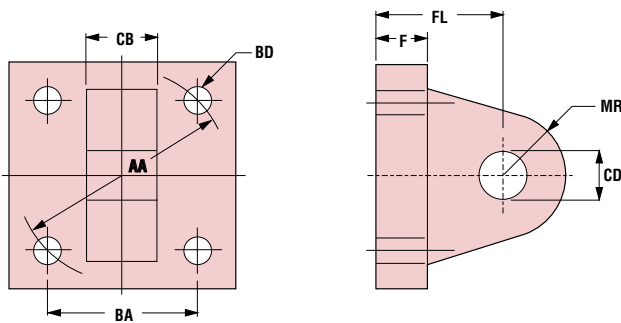

Eye Bracket

Part No.	AA	BA	BD	CB	CD	F _{max}	FL	MR _{max}
CH-8925	40	28,3	5,5	12	10	10	23	12
CH-8932	47	33,2	6,6	16	12	10	29	17
CH-8940	59	41,7	9	20	14	10	29	17
CH-8950	74	52,3	13,5	30	20	16	48	29
CH-8963	91	64,3	13,5	30	20	16	48	29
CH-8980	117	82,7	17,5	40	28	20	59	34
CH-89100	137	96,9	17,5	50	36	25	79	50
CH-89125	178	125,9	24	60	45	30	87	53
CH-89160	219	154,9	30	70	56	40	103	59
CH-89200	269	190,2	33	80	70	50	132	78

All dimensions in millimetres unless otherwise stated.

Accessories

Rod End Accessory Combinations

Thread KK	Rod Eye with Spherical Bearing	Clevis Bracket for Spherical Bearing and Pivot Pin
M10 x 1,25	CSH-9310	CSH-133-25
M12 x 1,25	CSH-9312	CSH-133-32
M14 x 1,5	CSH-9314	CSH-133-40
M16 x 1,5	CSH-9316	CSH-133-50
M20 x 1,5	CSH-9320	CSH-133-63
M27 x 2	CSH-9327	CSH-133-80
M33 x 2	CSH-9333	CSH-133-100
M42 x 2	CSH-9342	CSH-133-125
M48 x 2	CSH-9348	CSH-133-160
M64 x 3	CSH-9364	CSH-133-200

Cap End Mounting – Clevis Bracket for Spherical Bearing and Pivot Pin for IHMCS Mount

Bore Diameter (mm)	Clevis Bracket for Spherical Bearing and Pivot Pin
25	CSH-133-25
32	CSH-133-32
40	CSH-133-40
50	CSH-133-50
63	CSH-133-63
80	CSH-133-80
100	CSH-133-100
125	CSH-133-125
160	CSH-133-160
200	CSH-133-200

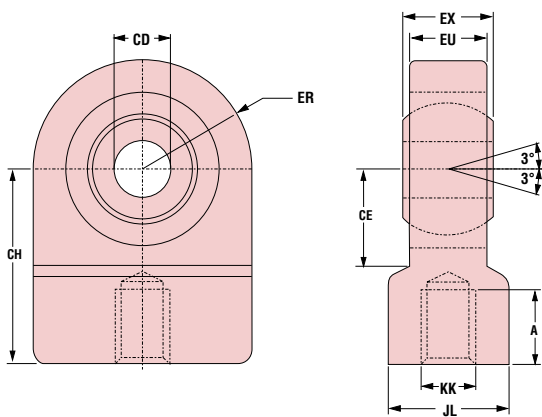

Rod Eye with Spherical Bearing

Part No.	A _{min}	CD	CE _{min}	CH	ER _{max}	EU	EX	JL _{max}	KK
CSH-9310	15	12 ^{+0,000} _{-0,008}	16	42	20	8	10 ^{+0,000} _{-0,120}	17	M10 x 1,25
CSH-9312	17	16 ^{+0,000} _{-0,008}	20	48	22,5	11	14 ^{+0,000} _{-0,120}	21	M12 x 1,25
CSH-9314	19	20 ^{+0,000} _{-0,012}	25	58	27,5	13	16 ^{+0,000} _{-0,120}	25	M14 x 1,5
CSH-9316	23	25 ^{+0,000} _{-0,012}	30	68	32,5	17	20 ^{+0,000} _{-0,120}	30	M16 x 1,5
CSH-9320	29	30 ^{+0,000} _{-0,012}	35	85	40	19	22 ^{+0,000} _{-0,120}	36	M20 x 1,5
CSH-9327	37	40 ^{+0,000} _{-0,012}	45	105	50	23	28 ^{+0,000} _{-0,120}	45	M27 x 2
CSH-9333	46	50 ^{+0,000} _{-0,012}	58	130	62,5	30	35 ^{+0,000} _{-0,120}	55	M33 x 2
CSH-9342	57	60 ^{+0,000} _{-0,015}	68	150	80	38	44 ^{+0,000} _{-0,150}	68	M42 x 2
CSH-9348	64	80 ^{+0,000} _{-0,015}	92	185	102,5	47	55 ^{+0,000} _{-0,150}	90	M48 x 2
CSH-9364	86	100 ^{+0,000} _{-0,020}	116	240	120	57	70 ^{+0,000} _{-0,200}	110	M64 x 3

All dimensions in millimetres unless otherwise stated.

Common Options Section

Rod End Types

In addition to selecting the correct bore, you must specify the appropriate rod size and rod end configuration for your application.

Five different rod end configurations are available. If a custom design is

required, contact your local Hydro-Line sales engineer, and define your requirements.

The table on page 39 gives maximum allowable push strokes at various operating pressures for

available rod diameters of Series IHM cylinders. Rod ends on rigid mount cylinders should be supported. Longer strokes are allowable for **pull only** applications. Contact your local Hydro-Line sales engineer for application assistance if necessary.

2		2X	
4		7	
5		For rod sizes 90, 110, and 140	

Dimensions in millimetres

Rod

MM	D	DC	Metric Thread							
			CC	AI	AX	KF	AF	KK	A	NA
12	10	–	M10 x 1,25	14	22	M8 x 1	12	M8 x 1	12	11
14	12	–	M12 x 1,25	16	24	M10 x 1,25	14	M10 x 1,25	14	13
18	15	–	M14 x 1,5	18	28	M12 x 1,25	16	M10 x 1,25	14	16,5
22	18	–	M16 x 1,5	22	32	M16 x 1,5	22	M12 x 1,25	16	20,5
28	22	–	M20 x 1,5	28	40	M20 x 1,5	28	M14 x 1,5	18	26
36	30	–	M27 x 2	36	54	M27 x 2	36	M16 x 1,5	22	34
45	38	–	M33 x 2	45	66	M33 x 2	45	M20 x 1,5	28	43
56	48	–	M42 x 2	56	84	M42 x 2	56	M27 x 2	36	53
70	62	–	M48 x 2	63	96	M48 x 2	63	M33 x 2	45	67
90	–	8	M64 x 3	85	128	M64 x 3	85	M42 x 2	56	87
110	–	10	M80 x 3	95	140	M80 x 3	95	M48 x 2	63	106
140	–	12	M100 x 3	112	168	M100 x 3	112	M64 x 3	85	136

See pages 9 through 23 for C dimensions.

Port Type and Size

Available Ports

Series IHM cylinders are available with SAE straight thread O-ring ports and the alternate ports listed below.

The table below lists the port types and sizes available for each bore diameter. The table on page 40 lists the maximum piston velocities obtainable with each bore diameter and port type combination.

Some mounting styles have location restrictions. Where a port or port boss interferes with cylinder mounting, mounting takes precedence. See page 34 for a table of port location availability.

Code S, T and A

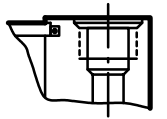

SAE straight thread O-ring seal port

Code U and B

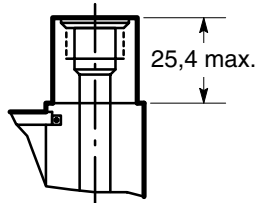

▲When boss is required

Code F

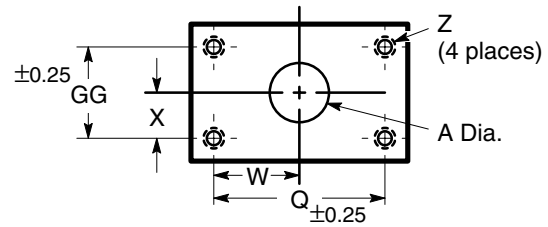

Dimensions in mm

Flange Size	A	Q	W	X	Z	GG
19	19,1	47,63	23,8	11,15	M10 x 1,5	22,23
25	25,4	52,37	26,2	13,1	M10 x 1,5	26,19
32	31,6	58,72	29,35	15,1	M12 x 1,75	30,18
38	38,1	69,85	34,95	17,85	M12 x 1,75	35,71

Code G and D

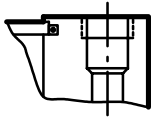

Code H and E

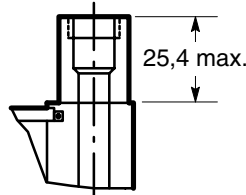

▲When boss is required

Bore Ø (mm)	Port Code									
	S	U	T ^A	F	G ^D	H	D	E	A	B
	SAE J1926 UN Thread O-ring / Thread Size			ISO 6162.2 Code 61 Flange	ISO 228-1 BSPP		DIN 3852 Form X Metric		ISO 6149-1	
25	9/16-18 (-6)	3/4-16 (-8)▲	-	-	G ^{1/4}	G ^{3/8} ▲	M14 x 1,5	M22 x 1,5▲	M14 x 1,5	M22 x 1,5▲
32	9/16-18 (-6)	3/4-16 (-8)▲	-	-	G ^{1/4}	G ^{3/8} ▲	M14 x 1,5	M22 x 1,5▲	M14 x 1,5	M22 x 1,5▲
40	9/16-18 (-6)	7/8-14 (-10)	3/4-16 (-8)	-	G ^{3/8}	G ^{1/2}	M22 x 1,5	M27 x 2▲	M22 x 1,5	M27 x 2▲
50	9/16-18 (-6)	7/8-14 (-10)	3/4-16 (-8)	-	G ^{1/2}	G ^{3/4} ▲	M22 x 1,5	M27 x 2▲	M22 x 1,5	M27 x 2▲
63	9/16-18 (-6)	7/8-14 (-10)	3/4-16 (-8)	-	G ^{1/2}	G ^{3/4} ▲	M22 x 1,5	M27 x 2▲	M22 x 1,5	M27 x 2▲
80	7/8-14 (-10)	1 3/16-12 (-14)	1 1/16-12 (-12)	19	G ^{3/4}	G1▲	M27 x 2	M33 x 2▲	M27 x 2	M33 x 2▲
100	7/8-14 (-10)	1 3/16-12 (-14)	1 1/16-12 (-12)	19	G ^{3/4}	G1▲	M27 x 2	M33 x 2▲	M27 x 2	M33 x 2▲
125	7/8-14 (-10)	1 3/16-12 (-14)	1 1/16-12 (-12)	19	G1	G1 1/4▲	M27 x 2	M33 x 2	M27 x 2	M33 x 2
160	1 1/16-12 (-12)	1 5/8-12 (-20)▲	1 5/16-12 (-16)	25	G1	G1 1/4▲	M33 x 2	M42 x 2	M33 x 2	M42 x 2▲
200	1 5/16-12 (-16)	1 5/8-12 (-20)	1 7/8-12 (-24)	38	G1 1/4	G1 1/2	M48 x 2	-	M48 x 2	-

^A - Size per ANSI B93.75M.

^D - Conforms to DIN 24554.

Port Locations

Port locations are identified by viewing the cylinder from the head end (or from the mounting end of double rod cylinders). The location numbers are shown below.

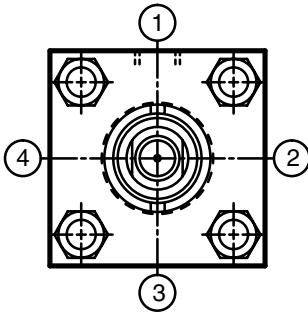

Certain port locations cannot be specified with some mounting styles. The table below indicates which of the head and cap port locations are available for each Series IHM mounting style. Ports in location 1 only for 25-32mm bores.

Mounting Style Code	Description	Head Locations				Cap Locations			
		1	2	3	4	1	2	3	4
A	Side lug	A	W	A	W	A	W	A	W
AK	Keyed side lug	A	W	A	W	A	W	A	W
DHMG	Head rectangular	A	A	A	A	A	A	A	A
G	Head rectangular	A	A	A	A	A	A	A	A
C	Clevis	A	A	A	A	A	A	A	A
CS	Spherical bearing	A	A	A	A	A	A	A	A
P	Cap rectangular	A	A	A	A	A	A	A	A
TT	Intermediate trunnion	A	A	A	A	A	A	A	A
W	Cap trunnion	A	A	A	A	A	N	A	N
U	Head trunnion	A	N	A	N	A	A	A	A
N	Cap extended tie rod	A	A	A	A	A	A	A	A
M	Head extended tie rod	A	A	A	A	A	A	A	A
L	Both ends extended tie rod	A	A	A	A	A	A	A	A
K	No mount	A	A	A	A	A	A	A	A
AD	Double rod, side lug	A	W	A	W				
GD	Double rod, head rectangular	A	A	A	A				
TTD	Double rod, intermediate trunnion	A	A	A	A				
UD	Double rod, head trunnion	A	N	A	N				
MD	Double rod, extended tie rod	A	A	A	A				
LD	Double rod, both ends extended tie rod	A	A	A	A				
KD	Double rod, no mount	A	A	A	A				
CE	Cap fixed eye	A	A	A	A	A	A	A	A

A – Available

N – Not available

W – Port available without port boss only.
Proximity switch not available.

Sealing Systems

Three different sealing systems are available in Series IHM cylinders.

Determine the correct seal codes for your application, then enter them in the model code.

Code	Fluid	Temperature (°C)	Max. Speed (m/s)	Application
H, B	Mineral oil, petroleum base Automotive transmission fluid	-35 to 80	0,7	Normal, typical industrial
F	Mineral oil	-35 to 120	5	Low friction servo
	Water glycol (HFC)	10 to 70	1	Fire retardant fluids
	Oil-in-water emulsions (HFA)			
	Water-in-oil emulsions (HFB)			
T	Mineral oil	-25 to 200	5	High temperature
	Phosphate esters, petroleum oil blends	0 to 200	5	Fire retardant fluids
	Fyrquel 220, 550, 1000			
	Hought-O-Safe 1340			
	Pydraul 200, 230C, 280, 312C, 540C, A200			

Gland Drain Option

Gland drains are primarily used for long stroke cylinders (over 1 m) and when extended speed exceeds retract speed.

The gland drain is used to return any accumulated fluid, between the rod seal and wiper, to tank. This is used in servo applications, for ultra-low leakage requirements, or for remote visual monitoring of rod seal leakage for preventive maintenance purposes.

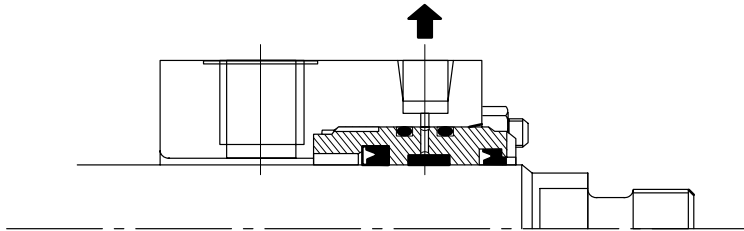

Air Bleed Option

Usually cylinders will bleed themselves of air when ports are vertical, on top. Bleed ports are often desirable to remove entrapped air, when the ports are on the bottom. High performance and high speed or heavy load applications are a few examples where air bleeds are desirable.

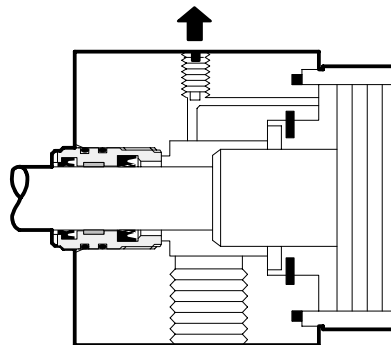

Proximity Switches

Proximity switches for Series IHM cylinders are inductive type switches with a sensing probe that “looks” at the cushion collar or button to provide full extend or full retract indication. Since the probe is inside the cylinder, harsh external environments don’t affect sensing. The 2-wire circuit will operate on AC or DC and works as reliably as a programmable controller. Proximity switches meet UL requirements for 210

bar hydraulic cylinders. Hydro-Line switch adaptor allows full 360° rotation.

Short Circuit Protection is a standard feature on the Proximity Switch. SCP protects the switch from shorts in the load or line. Upon sensing a short condition, the switch assumes a non-conducting mode. The fault condition must be removed and power turned off in order to reset the switch.

This feature prevents unintended automatic restarts. The switch indicates when it is in SCP mode by flashing both LEDs.

Torque 1/4–20 mounting screws to 20 Nm (15 ft-lb).

O-rings required:

Size 115 – One per switch
Size 116 – One per spacer

Series 2-wire AC/DC Proximity Switches

Pressure	210 bar
Sensing range	2,0 mm ±10%
Operating temperature range	-20° to +70°C
Repeatability	0,025 mm
Switching differential	10%
Supply voltage	20–220 V AC/DC
On-State voltage drop	10V @ 5–500 mA
Load current man.	0,5 Amp
Inrush current	3 Amp
Quiescent current	1,7 mA max.
Indicating LED's (standard)	1 lit: Power on non-conducting 2 lit: Target present (both flashing = SCP mode)

Dimensions in millimetres

Bore Ø	Rod Ø	Max. D	
25	12	N/A	
	18	N/A	
	Cap	N/A	
32	14	N/A	
	22	N/A	
	Cap	N/A	
40	18	94	
	22	94	
	28	94	
	Cap	94	
50	22	104	
	28	97	
	36	97	
	Cap	97	
	63	28	113
63	36	113	
	45	113	
	Cap	113	
	80	36	115
80	45	115	
	56	121	
	Cap	115	
	100	45	132
	100	56	121
70		121	
Cap		121	
125		56	157
125		70	157
	90	157	
	Cap	157	
	160	70	157
	160	90	167
110		165	
Cap		157	
200		90	189
200	110	182	
	140	182	
	Cap	182	

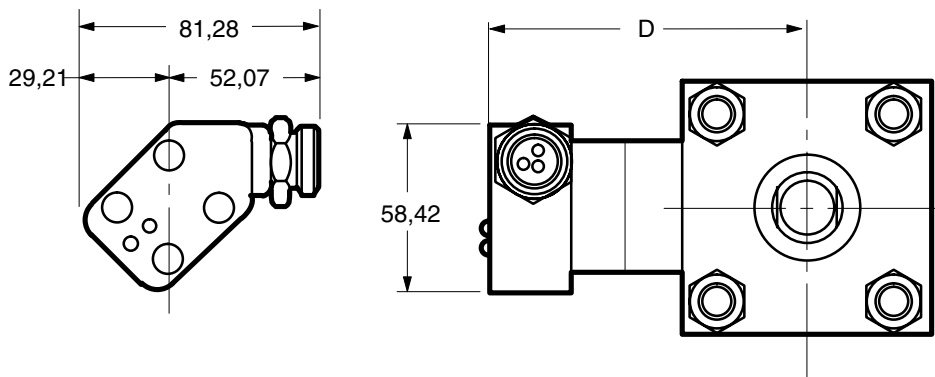

With the new Hydro-Line switch adaptor, the proximity switch can rotate 360°. Use the chart on previous page for available proximity switch locations for the various mounting styles.

Application / Engineering Data

Stop Tube Selection

The following table lists the maximum stroke permissible without the use of a stop tube. Strokes are listed for rigid mounting styles as well as clevis and trunnion pivot mounts.

As the stroke length of a cylinder increases, the resultant bearing loads on the piston rod become greater. To keep these bearing loads from exceeding design limitations, and to obtain optimum life from a cylinder, stop tubes should be specified according to the following procedure:

To order a stop tube, enter an X suffix in the model code. Then specify the cylinder's working stroke and the required stop tube length. Specify 25 mm of stop tube for each 250 mm (or fraction thereof) of stroke in excess of the maximums listed in the table.

Bore Ø (mm)	Maximum Stroke (mm)		
	Pivot Mounts	Rigid mounts	
		Unsupported Rod	Supported Rod
25	500	600	1000
32	500	600	1000
40	600	750	1200
50	600	750	1200
63	750	965	1200
80	750	965	1200
100	750	965	1200
125	900	1000	1200
160	900	1000	1200
200	900	1000	1200

Stop Tube Designs

Three typical stop tube designs are illustrated below.

Design A

Used for cylinders not cushioned on the rod end.

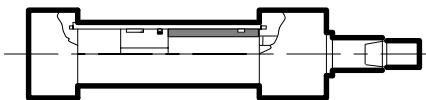

Design B

Used for cushioned hydraulic cylinders.

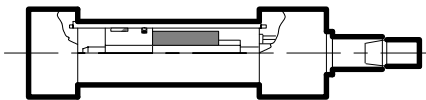

Design C

The best choice for a cylinder with an exceptionally long stop tube requirement. Note that the piston's effective bearing area is doubled, in addition to gaining the normal increased

minimum distance between bearing points.

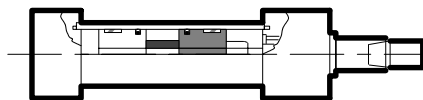

Tie Rod Spacers and Center Supports

A tie rod spacer or center support should be applied when the stroke length exceeds 20 times the bore diameter.

Tie rod spacer

Tie rod spacers and center supports are used to improve the structural rigidity of long stroke tie rod cylinders.

The spacers have through holes for the tie rods and are held in place on the cylinder barrel with a small tack weld or set screw.

The spacer keeps the tie rod in the proper position around the centerline of the cylinder and acts much like a truss in preventing excessive deflection in a long stroke cylinder that is not rigidly mounted (clevis mount, etc.).

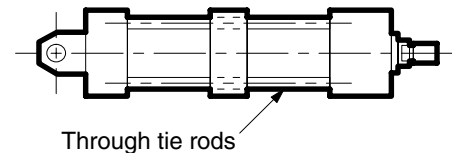

Tie rod center support

The center support has side mounting lugs similar to side lug mount heads and serves as an additional mounting location. The tie rods are threaded into the center support and it becomes a load-carrying component of the cylinder assembly.

The exact location of the tie rod center support is generally optional, which greatly increases the flexibility in mounting a long stroke cylinder.

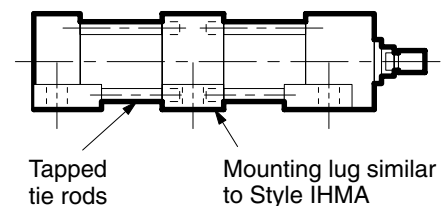

Tapped tie rods

Mounting lug similar to Style IHMA

Bore & Rod Diameters

Cylinder Size Selection

To choose the proper size of cylinder for your application, first determine the maximum push and/or pull force required to do the job. Then use the table below to select the cylinder that will provide that force. Remember that force capabilities derived from charts

and formulas may be theoretically correct, but other factors must be considered. Be sure to allow for pressure drop between the pump outlet and the cylinder port. Also, some of a cylinder's force is used up overcoming seal friction and, to a lesser extent, the inertia of the piston itself. In Hydro-Line cylinders, the amount of extra force needed to compensate for these factors has been limited to 5% or less of the

cylinder's theoretical power—without sacrificing sealing performance.

For maximum reliability and fatigue life of the piston rod, the largest rod offered in a given bore size should be specified. The smaller rods for a given bore are primarily intended for short stroke push loading or reduced pressure applications.

Bore ∅ (mm)	Rod ∅ (mm)	Work Area (cm ²)	Maximum Force (kN) At Working Pressure (bar)						
			30 (bar)	50 (bar)	70 (bar)	100 (bar)	140 (bar)	160 (bar)	210 (bar)
25	—	4,9	1,47	2,45	3,44	4,91	6,87	7,85	10,31
	12	3,8	1,13	1,89	2,64	3,78	5,29	6,04	7,93
	18	2,4	0,71	1,18	1,65	2,36	3,31	3,78	4,96
32	—	8,0	2,41	4,02	5,63	8,04	11,26	12,87	16,89
	14	6,5	1,95	3,25	4,55	6,50	9,10	10,40	13,66
	22	4,2	1,27	2,12	2,97	4,24	5,94	6,79	8,91
40	—	12,6	3,77	6,28	8,80	12,57	17,59	20,11	26,39
	18	10,0	3,01	5,01	7,02	10,02	14,03	16,03	21,05
	22	8,8	2,63	4,38	6,14	8,77	12,27	14,03	18,41
	28	6,4	1,92	3,20	4,49	6,41	8,97	10,25	13,46
50	—	19,6	5,89	9,82	13,74	19,63	27,49	31,42	41,23
	22	15,8	4,75	7,92	11,08	15,83	22,17	25,33	33,25
	28	13,5	4,04	6,74	9,44	13,48	18,87	21,57	28,31
	36	9,5	2,84	4,73	6,62	9,46	13,24	15,13	19,86
63	—	31,2	9,35	15,59	21,82	31,17	43,64	49,88	65,46
	28	25,0	7,50	12,51	17,51	25,01	35,02	40,02	52,53
	36	21,0	6,30	10,50	14,70	21,00	29,39	33,59	44,09
	45	15,3	4,58	7,63	10,69	15,27	21,38	24,43	32,06
80	—	50,3	15,08	25,13	35,19	50,27	70,37	80,42	105,56
	36	40,1	12,03	20,04	28,06	40,09	56,12	64,14	84,18
	45	34,4	10,31	17,18	24,06	34,37	48,11	54,99	72,17
	56	25,6	7,69	12,82	17,94	25,64	35,89	41,02	53,83
100	—	78,5	23,56	39,27	54,98	78,54	109,96	125,66	164,93
	45	62,6	18,79	31,32	43,84	62,64	87,69	100,22	131,53
	56	53,9	16,18	26,96	37,74	53,92	75,48	86,27	113,23
	70	40,1	12,02	20,03	28,04	40,06	56,08	64,09	84,12
125	—	122,7	36,82	61,36	85,90	122,72	171,81	196,35	257,71
	56	98,1	29,43	49,04	68,66	98,09	137,32	156,94	205,99
	70	84,2	25,27	42,12	58,97	84,24	117,94	134,79	176,91
	90	59,1	17,73	29,55	41,37	59,10	82,74	94,56	124,11
160	—	201,1	60,32	100,53	140,74	201,06	281,49	321,70	422,23
	70	162,6	48,77	81,29	113,80	162,58	227,61	260,12	341,41
	90	137,5	41,24	68,73	96,22	137,46	192,45	219,94	288,67
	110	106,0	31,81	53,01	74,22	106,03	148,44	169,65	222,66
200	—	314,2	94,25	157,08	219,91	314,16	439,82	502,65	659,73
	90	250,5	75,16	125,27	175,38	250,54	350,76	400,87	526,14
	110	219,2	65,75	109,58	153,41	219,15	306,82	350,65	460,22
	140	160,2	48,07	80,11	112,15	160,22	224,31	256,35	336,46

Maximum Allowable Push Strokes

In push applications, a cylinder acts as a loaded column. There are two basic ways to measure the column length.

Pivot mounts:

The length is measured from the pivot point to the end of the rod in the fully extended position.

Flange and other rigid mounts:

The exposed piston rod is considered to be the column length with a fixed end at the cylinder which allows longer strokes.

To use the table below, first go to the section for your mounting style. Then locate the column which is closest to, but not below, your application's operating pressure. The intersection of

operating pressure and bore/rod size represents the maximum allowable push stroke. This maximum stroke is based on column loading analysis only and does not consider side loading, stop tube requirements or other cylinder stroke limiters.

For pressures above 210 bar, consult your local Hydro-Line representative.

BORE ROD Ø (mm) Ø (mm)		Maximum Stroke (mm) at Working Pressure (bar)																	
		Rigid Mounts (A, AK, CE, G, L, M, N, P, AD, GD, LD, and MD)						Cap Swivel Mounts (C, CS, and W)						Trunnion Mounts (TT, TTD, U, and UD)					
		30	50	70	100	160	210	30	50	70	100	160	210	30	50	70	100	160	210
25	12	758	566	460	361	243	175	337	252	205	161	108	78	404	302	246	193	130	94
18	18	1754	1339	1114	910	684	569	780	595	495	405	304	253	936	714	595	486	365	304
32	14	797	591	475	366	230	145	355	263	211	163	102	64	425	315	254	195	123	77
22	22	2042	1556	1293	1054	787	651	908	692	575	469	350	289	1090	831	690	562	420	347
40	18	1058	786	635	491	317	211	471	350	282	219	141	94	565	419	339	262	169	112
22	22	1612	1216	999	799	569	446	717	541	444	355	253	198	860	649	533	426	304	238
28	28	2649	2020	1680	1370	1025	850	1178	898	747	609	456	378	1414	1078	896	731	547	454
50	22	1261	935	753	580	367	234	561	416	335	258	163	104	673	499	402	309	196	125
28	28	2091	1579	1299	1041	745	588	930	702	578	463	331	261	1116	843	693	556	398	314
36	36	3508	2677	2228	1820	1367	1138	1560	1191	991	810	608	506	1872	1429	1189	971	730	607
63	28	1623	1204	971	750	479	311	722	536	432	333	213	138	866	643	518	400	255	166
36	36	2748	2077	1711	1374	989	785	1222	924	761	611	440	349	1466	1109	913	733	528	419
45	45	4348	3318	2761	2254	1691	1407	1934	1475	1228	1003	752	626	2321	1771	1473	1203	903	751
80	36	2116	1572	1269	983	634	422	941	699	564	437	282	187	1129	839	677	525	338	225
45	45	3377	2551	2099	1683	1206	953	1502	1134	934	748	536	424	1802	1361	1120	898	644	508
56	56	5298	4040	3359	2740	2050	1701	2356	1797	1494	1219	912	756	2827	2156	1793	1462	1094	908
100	45	2645	1965	1587	1229	792	527	1176	874	706	546	352	234	1412	1049	847	656	423	281
56	56	4183	3158	2599	2082	1490	1175	1860	1405	1156	926	663	523	2232	1686	1387	1111	795	627
70	70	6623	5050	4199	3425	2563	2126	2945	2246	1867	1523	1140	945	3534	2695	2241	1828	1368	1134
125	56	3275	2432	1963	1518	976	644	1457	1082	873	675	434	286	1748	1298	1047	810	521	344
70	70	5228	3948	3248	2603	1863	1469	2325	1756	1445	1158	828	653	2790	2107	1733	1389	994	784
90	90	8769	6693	5571	4551	3418	2846	3900	2976	2477	2024	1520	1266	4680	3572	2973	2429	1824	1519
160	70	3986	2953	2376	1828	1151	724	1773	1313	1057	813	512	322	2127	1576	1268	975	614	386
90	90	6754	5102	4199	3366	2412	1905	3004	2269	1867	1497	1073	847	3605	2723	2241	1796	1287	1017
110	110	10212	7782	6467	5269	3933	3254	4542	3461	2876	2343	1749	1447	5450	4153	3451	2812	2099	1736
200	90	5290	3930	3173	2457	1584	1054	2353	1748	1411	1093	705	469	2823	2097	1693	1311	846	562
110	110	8058	6079	4995	3995	2844	2228	3584	2703	2222	1777	1265	991	4300	3244	2666	2132	1518	1189
140	140	13245	10100	8398	6850	5126	4252	5890	4491	3735	3046	2279	1891	7068	5390	4482	3656	2735	2269

Port Selection

Use this table to determine which bore diameter, rod diameter, and port combination will provide the piston velocity required for your application.

Bore Ø (mm)	Rod Ø (mm)	Fluid Req. per 10 mm of of Stroke (l)	Port Code S		Port Codes B, E and U		Port Codes A, D, F, and T		Port Code G		Port Code H	
			Flow (l/min)	Piston Velocity (m/s)	Flow (l/min)	Piston Velocity (m/s)	Flow (l/min)	Piston Velocity (m/s)	Flow (l/min)	Piston Velocity (m/s)	Flow (l/min)	Piston Velocity (m/s)
25	Cap	0,0049	13,4	0,46	23,2	0,79	13,4	0,46	4,5	0,15	13,4	0,46
	12	0,0038	13,4	0,59	23,2	1,02	13,4	0,59	4,5	0,20	13,4	0,59
	18	0,0024	13,4	0,94	23,2	1,64	13,4	0,94	4,5	0,32	13,4	0,94
32	Cap	0,0080	13,4	0,28	23,2	0,48	13,4	0,28	4,5	0,09	13,4	0,28
	14	0,0065	13,4	0,34	23,2	0,60	13,4	0,34	4,5	0,12	13,4	0,34
	22	0,0042	13,4	0,53	23,2	0,91	13,4	0,53	4,5	0,18	13,4	0,53
40	Cap	0,0126	13,4	0,18	35,6	0,47	23,2	0,31	13,4	0,18	23,2	0,31
	18	0,0100	13,4	0,22	35,6	0,59	23,2	0,39	13,4	0,22	23,2	0,39
	22	0,0088	13,4	0,25	35,6	0,68	23,2	0,44	13,4	0,25	23,2	0,44
	28	0,0064	13,4	0,35	35,6	0,93	23,2	0,60	13,4	0,35	23,2	0,60
50	Cap	0,0196	13,4	0,11	35,6	0,30	23,2	0,20	23,2	0,20	56,4	0,48
	22	0,0158	13,4	0,14	35,6	0,38	23,2	0,24	23,2	0,24	56,4	0,59
	28	0,0135	13,4	0,17	35,6	0,44	23,2	0,29	23,2	0,29	56,4	0,70
	36	0,0095	13,4	0,24	35,6	0,63	23,2	0,41	23,2	0,41	56,4	0,99
63	Cap	0,0312	13,4	0,07	35,6	0,19	23,2	0,12	23,2	0,12	56,4	0,30
	28	0,0250	13,4	0,09	35,6	0,24	23,2	0,16	23,2	0,16	56,4	0,38
	36	0,0210	13,4	0,11	35,6	0,28	23,2	0,18	23,2	0,18	56,4	0,45
	45	0,0153	13,4	0,15	35,6	0,39	23,2	0,25	23,2	0,25	56,4	0,62
80	Cap	0,0503	35,6	0,12	78,6	0,26	56,4	0,19	56,4	0,19	108,3	0,36
	36	0,0401	35,6	0,15	78,6	0,33	56,4	0,23	56,4	0,23	108,3	0,45
	45	0,0344	35,6	0,17	78,6	0,38	56,4	0,27	56,4	0,27	108,3	0,53
	56	0,0256	35,6	0,23	78,6	0,51	56,4	0,37	56,4	0,37	108,3	0,70
100	Cap	0,0785	35,6	0,08	78,6	0,17	56,4	0,12	108,3	0,12	108,3	0,23
	45	0,0626	35,6	0,10	78,6	0,21	56,4	0,15	108,3	0,29	108,3	0,29
	56	0,0539	35,6	0,11	78,6	0,24	56,4	0,17	108,3	0,33	108,3	0,33
	70	0,0401	35,6	0,15	78,6	0,33	56,4	0,24	108,3	0,45	108,3	0,45
125	Cap	0,1227	35,6	0,05	78,6	0,11	108,3	0,15	108,3	0,15	176,6	0,24
	56	0,0981	35,6	0,06	78,6	0,13	108,3	0,18	108,3	0,18	176,6	0,30
	70	0,0842	35,6	0,07	78,6	0,16	108,3	0,21	108,3	0,21	176,6	0,35
	90	0,0591	35,6	0,10	78,6	0,22	108,3	0,30	108,3	0,30	176,6	0,50
160	Cap	0,2011	56,4	0,05	176,6	0,15	108,3	0,09	108,3	0,09	176,6	0,15
	70	0,1626	56,4	0,06	176,6	0,18	108,3	0,11	108,3	0,11	176,6	0,18
	90	0,1375	56,4	0,07	176,6	0,21	108,3	0,13	108,3	0,13	176,6	0,21
	110	0,1060	56,4	0,09	176,6	0,28	108,3	0,17	108,3	0,17	176,6	0,28
200	Cap	0,3142	108,3	0,06	176,6	0,09	261,7	0,14	176,6	0,09	261,7	0,14
	90	0,2505	108,3	0,07	176,6	0,12	261,7	0,17	176,6	0,12	261,7	0,17
	110	0,2192	108,3	0,08	176,6	0,13	261,7	0,20	176,6	0,13	261,7	0,27
	140	0,1602	108,3	0,11	176,6	0,18	261,7	0,27	176,6	0,18	261,7	0,27

Cushioning System

Hydro-Line cylinders have standard features that are extra cost options or not available on other look-alike ISO/DIN cylinders. IHM Series hydraulic cylinders are available with a patented floating ring cushion seal or alternate solid design with check valve that provide positive cushion sealing with minimum wear and maximum piston acceleration on the return stroke.

Advanced Cushions Provide Faster Cycle Times

Cylinder cushions are designed to decelerate the piston velocity near the end of each cylinder stroke to prevent excessive mechanical shock.

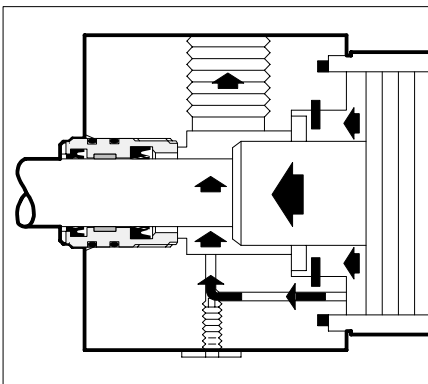

To accomplish this, the cushion collar contacts a floating sleeve or cylinder head which permits a very close seal contact without high loading. The sleeve seats against the head and provides a very effective seal to trap the fluid. Consistent performance and long life are provided.

Hydro-Line advanced cushions permit higher cylinder speed, shorter cycle time, and more work per hour.

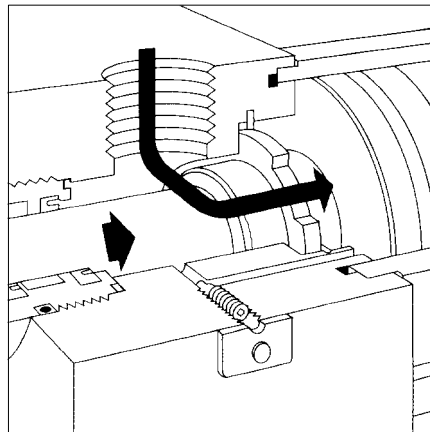

The sleeve design is also free to move in an axial direction and functions as a fluid check. When the fluid flow is reversed, the sleeve moves off its seat, and fluid flows around the slots in the outer sleeve's diameter permitting nearly full flow for quick acceleration.

Cushion Features

- Cushion design provides consistent long wearing seal between cushion collar and head.
- Floating design self-aligns to minimize wear.
- Check valve action of sleeve provides rapid acceleration out of the cushion.

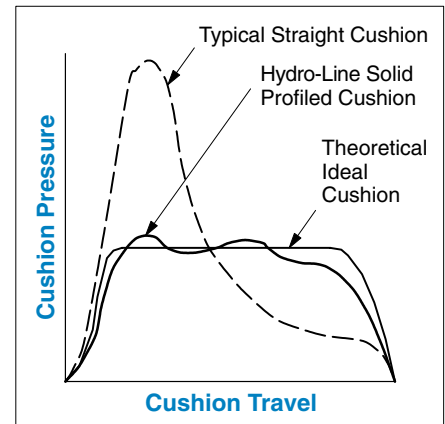

Cushions are recommended when piston speed exceeds 0,13 m/s. Any heavy loads attached to the piston rod should be absorbed by external means such as shock absorbers or springs.

Cushioning System

Key Assumptions & Limitations

These assumptions provide parameters for determining maximum cushion performance. Actual performance may be different than determined by these methods, particularly if assumptions are not maintained.

Efficiency factors are applied to the energy calculations that attempt to reflect characteristics of the Eaton cushion design.

The following assumptions should be considered when calculating cushion capacity:

- Maximum cushion pressure is 310 bar (4500 psi).
- The upper limit of velocity is 0.5 m/s.
- If velocity is below 0,13 m/s, the cushions become ineffective on cylinders smaller than 80 mm bore.
- Friction force is assumed to be zero.
- The cylinder is used in a linear system (not for rotary applications).
- Fluid viscosity is equivalent to 25 centistoke.
- The driving pressure is equal to the maximum system pressure, usually the relief valve setting.
- Cushion adjustment screws are provided to tune cushion performance within limits.
- Cushion efficiency (C_{eff}) is 0.67 for velocities between 0,1 and 0,3 m/s., or 0,5 for velocities between 0,3 and 0,5 m/s.

Application 1

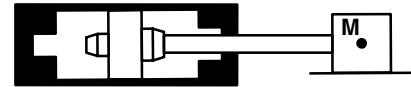

Application 2

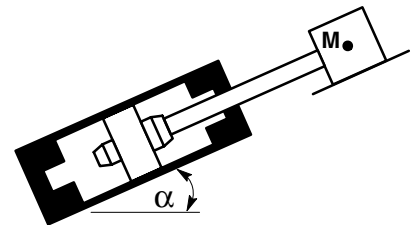

Application 3

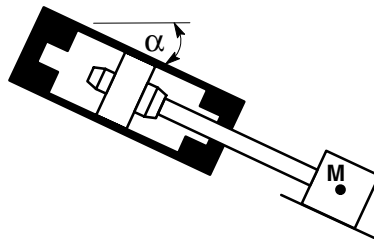

Application 1:

$$E = (1/C_{eff})[0,5 M V^2] \text{ extend or retract}$$

Application 2:

$$E = (1/C_{eff}) \{ [0,5 M V^2] - [9,81 M (L_{hc}/1000 (\sin \alpha))] \} \text{ extend}$$

$$E = (1/C_{eff}) \{ [0,5 M V^2] + [9,81 M (L_{cc}/1000 (\sin \alpha))] \} \text{ retract}$$

Application 3:

$$E = (1/C_{eff}) \{ [0,5 M V^2] + [9,81 M (L_{hc}/1000 (\sin \alpha))] \} \text{ extend}$$

$$E = (1/C_{eff}) \{ [0,5 M V^2] - [9,81 M (L_{cc}/1000 (\sin \alpha))] \} \text{ retract}$$

Calculations for IHM Cylinder

Units (US)

E	Energy	joule
M	Mass	kg
V	Velocity	m/s
P_d	Driving pressure	bar
L_H	Head cushion length	mm
L_C	Cap cushion length	mm
g	Gravity constant	9,81/1000

Example

IHM cylinder in application 3 and extending:

Using an IHM cylinder with a 100 mm bore, 45 mm rod is mounted at a 45° angle from horizontal with rod down. A 1300 kg mass is attached to the rod and system pressure is 100 bar. The cylinder is moving the mass at 0,3 m/s.

Using the calculation for application 3:

$$E = (1/C_{eff}) \{ [0,5 M V^2] + [9,81 M (L_{hc}/1000 (\sin \alpha))] \}$$

$$E = (1/0.67) \{ [0,5 * 1300 * 0,3^2] + [9,81 * 1300 * (33/1000) * \sin(45)] \}$$

$$E = 531 \text{ newton-m (joule)}$$

Pick the chart (see page 43) for IHM cylinder, rod extending, and first rod. The curve is for the 100/45 bore/rod. Enter the vertical axis at 531 newton-m and the horizontal axis at 100 bar. The point of intersection is below the 100/45 curve so the cushion is acceptable. The maximum allowable pressure on the cap end is 160 bar which is greater than the specified system pressure of 100 bar.

Cushion Data

Bore Diameter (mm)	Rod Diameter (mm)		Max. Cap Pressure (bar)	L _C Effective Cap End Cushion Length (mm)	L _H Effective Head End Cushion Length (mm)
25	12		210	17	20
25	18		112	17	20
32	14		210	17	20
32	22		136	17	20
40	18		210	26	23
40	22		158	26	25
40	28		124	26	30
50	22		210	26	28
50	28		210	26	28
50	36		91	26	30
63	28		210	26	21
63	36		160	26	30
63	45		115	26	30
80	36		210	30	30
80	45		210	30	30
80	56		118	30	35
100	45		210	32	33
100	56		210	32	35
100	70		131	32	35
125	56		210	40	40
125	70		210	40	40
125	80		119	40	35
160	70		210	40	40
160	90		210	40	38
160	110		141	40	37
200	90		210	55	40
200	110		210	55	40
200	140		136	55	40

Energy Absorbing Potential Charts

**IHM Cap Cushion - Rod Retracting
First Rod**

**IHM Rod Cushion - Rod Extending
First Rod**

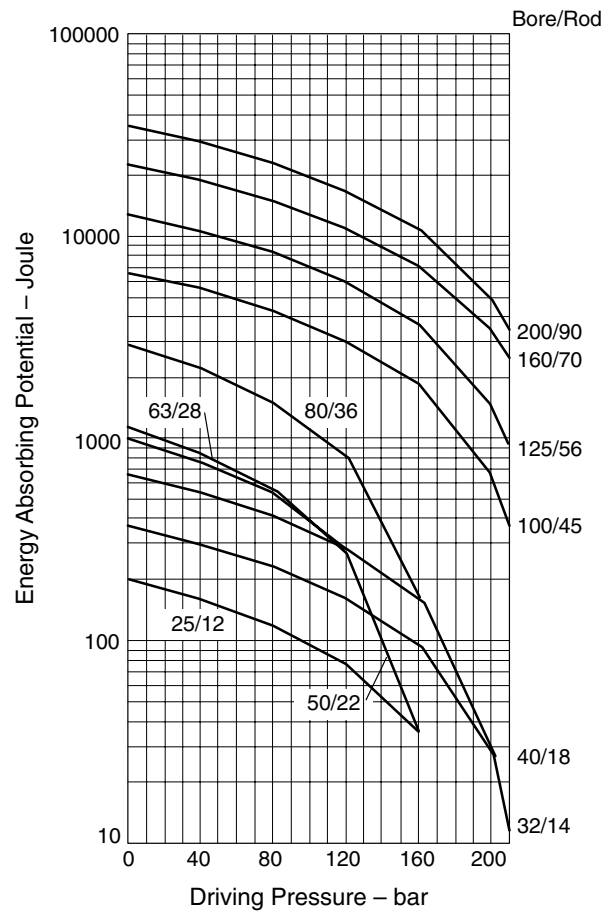
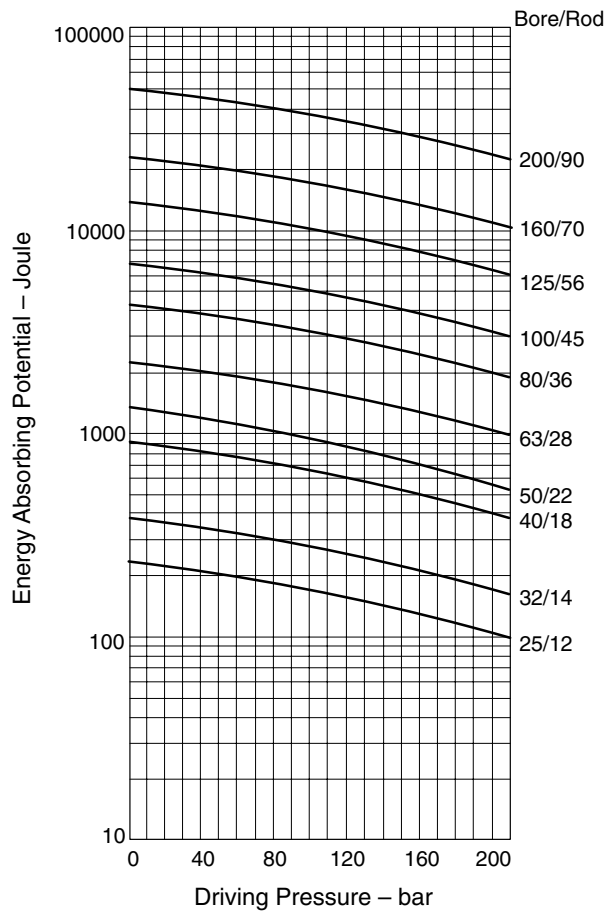

**IHM Cap Cushion - Rod Retracting
Second Rod**

**IHM Rod Cushion - Rod Extending
Second Rod**

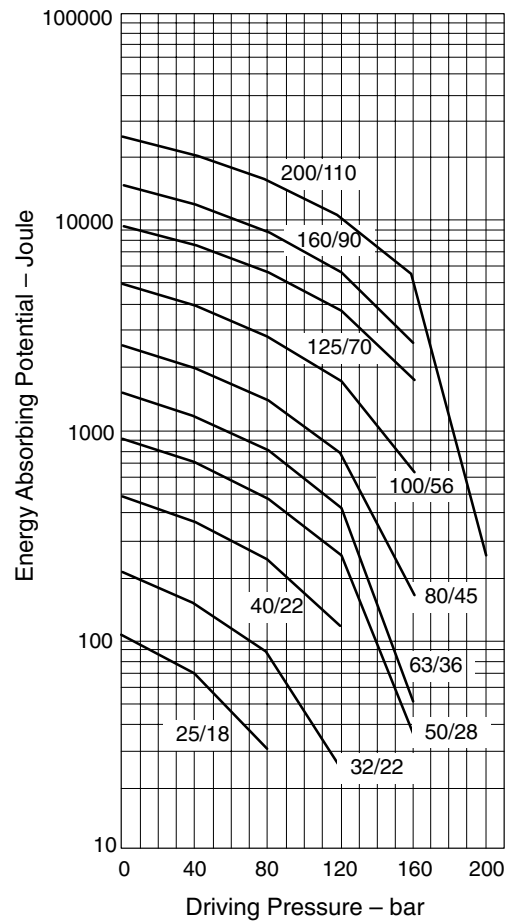
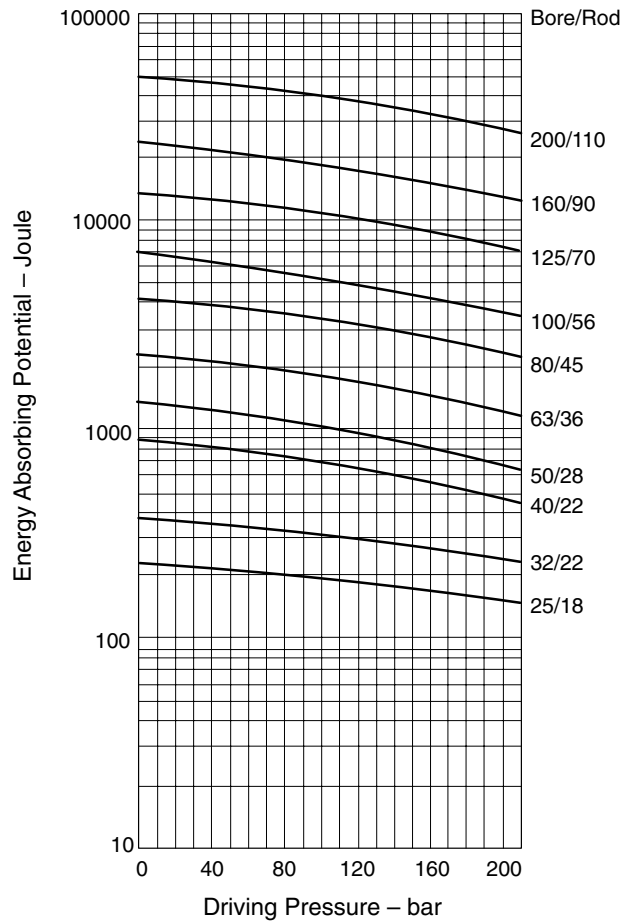

IHM Cap Cushion - Rod Retracting Third Rod

IHM Rod Cushion - Rod Extending Third Rod

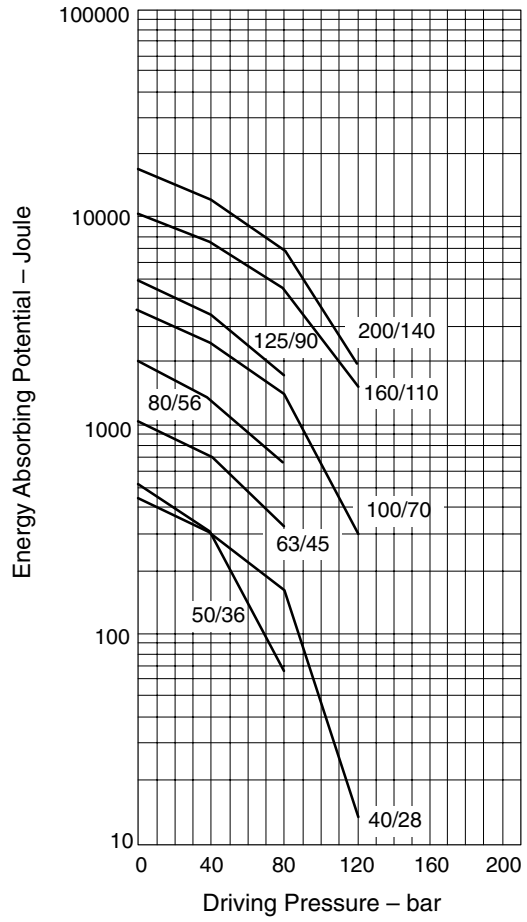
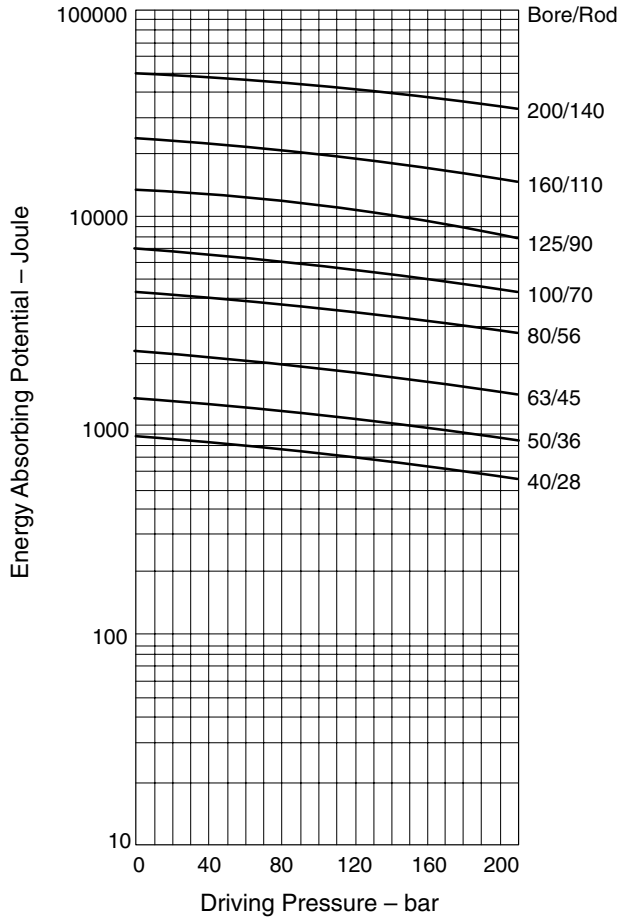

Weights

The following table lists approximate net weights of Series IHM cylinders.

Weights shown are based on cylinders with standard rod diameter and single rod end. All weights are expressed in kilograms.

Double rod cylinder weight is equal to 1,15 times chart weight plus weight due to stroke.

Approximate Cylinder Weights

Bore ∅ (mm)	Rod ∅ (mm)	Zero Length Weight (kg)				Single Rod Weight per mm of Stroke (kg)	Double Rod Weight per mm of Stroke (kg)
		IHMCS IHMN IHMM	IHMA IHMAK IHMC IHMCCE	IHMG IHMP IHMTT	IHMW IHMU IHML		
25	12	1,2	1,2	1,7	1,2	0,004	0,005
32	14	1,6	1,6	2,2	1,6	0,006	0,007
40	18	3,5	3,7	4,9	3,6	0,009	0,011
50	22	5,3	5,5	7,3	5,5	0,013	0,016
63	28	7,4	7,8	10,4	7,7	0,019	0,024
80	36	14,2	14,9	19,9	14,7	0,031	0,039
100	45	19,2	20,2	26,9	20,0	0,046	0,058
125	56	37,6	39,5	47,4	39,1	0,074	0,093
160	70	61,6	64,7	77,6	64,0	0,113	0,143
200	90	113,0	118,6	142,4	117,5	0,158	0,208

IHM Series Standard Design Options

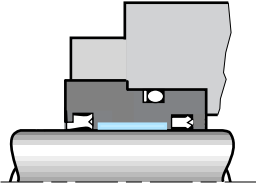

Double Lip Rod Wipers

A double lip Rod Wiper provides increased rod seal life by removing abrasive contamination from the rod in severe applications.

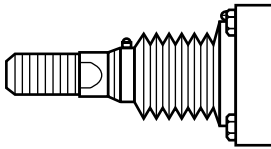

Rod Boot

A boot surrounds the piston rod with an external, expandable cover to protect the rod surface from external contamination. **Requires additional rod length which is determined by the cylinder stroke.**

Special Rod Ends

Modifications of standard rod ends or completely special rod end styles are available to meet unique rod end connection requirements.

Special Ports

Metric, NPTF, SAE, Manifold, Flange and other porting options are available to meet specific requirements.

Electronic Feedback

A complete line of precision cylinder position sensing and feedback devices are available. These packaged cylinder systems can handle virtually any application requiring feedback throughout the cylinder stroke — pneumatic or hydraulic, large or small bore, long or short strokes, with or without velocity monitoring — with resolutions of $\pm 0.00004\text{mm}$ or better. (See the Hydro-Line Systems Cylinder Catalog).

Rod Wearbands

Rod wearbands fitted to the rod cartridge eliminate metal-to-metal contact on the cartridge/rod O.D. Bronze-filled Teflon wearband material reduces friction and wear in applications where side-load is present.

Air Bleeders

Bleeders are located in the head and cap when specified, bleed screws are captive and may be located in positions 1, 2, 3, or 4.

Stainless Steel Piston Rods

Chrome plated piston rods in 17-4 PH stainless steel are available for those applications requiring increased corrosion resistance.

Special Coating and Painting

Cylinders can be prepared with a primer coat or epoxy, lacquer, or enamel paint finish coatings to customer specifications. Synergistic, Nitrocarburizing and other material treatments are also available for special applications.

Plating

Electroless Nickel, Cadmium and other plating finishes are available for corrosive, washdown, pharmaceutical, and other applications.

Special Materials

Bronze, brass, aluminum, stainless steel, or other special materials are available to meet most unique material requirements.

IHM Series Cylinder Types

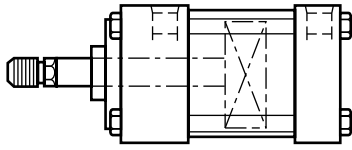

Single/Double Acting Cylinder

Standard HM Series cylinders are double acting, with fluid power driving the piston in both directions. Single acting cylinders have fluid power driving the piston in one direction, relying on either the load or an external force to return the piston after the pressure is released.

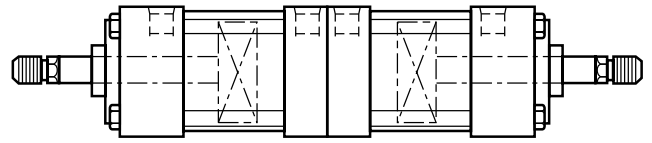

Back-to-Back Cylinders

Back-to-back cylinders are two single rod cylinders mounted together at the caps. Combinations of positions (3 positions) are possible through various combinations of piston actuation.

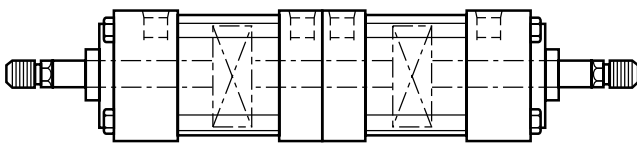

Double End Cylinders Back-to-Back

Double end cylinders mounted back-to-back have common piston rod and tie rods and the same stroke length.

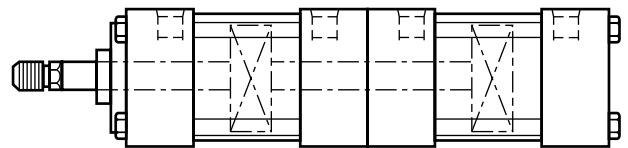

Tandem Cylinders

Tandem Cylinders consist of two cylinders interconnected (piston and rod assemblies are connected). Pressure can act on two effective piston areas allowing the cylinder to be used as a force multiplier. This type of cylinder can also be used in air/oil systems to provide smooth, metered flow because of equal volumes in one chamber of both cylinders.

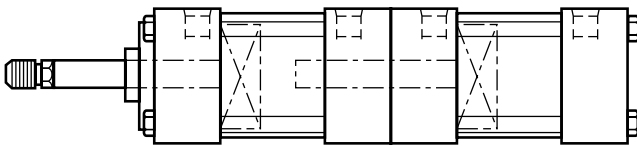

Multiple Position Cylinders

Multiple position cylinders are similar to tandem cylinders (except that the piston and rod assemblies are not connected) in that the output force is increased. Additionally, they may act as a precision multiple positioning device by actuating each cylinder successively or independently.

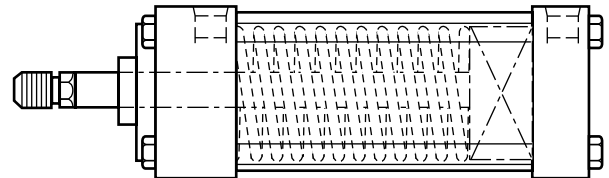

Spring Return/Extend Cylinders

Spring Return/Extend Cylinders provide thrust in one direction only (can be either direction). One port is used for pressure to act against the load while the inactive port is vented. An internal spring is used to return the cylinder to its normal position.

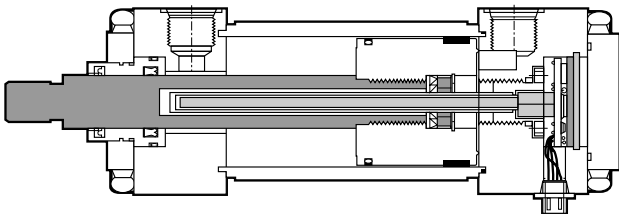

Systems Cylinders

Systems cylinders integrate electronics with hydraulics and pneumatics to provide precision cylinder sensing and feedback. Internal magnetostrictive or linear potentiometer transducers are added to the cylinder. Valve manifold blocks can also be added to provide a compact feedback cylinder package. (See Hydro-Line Systems Catalogue.)

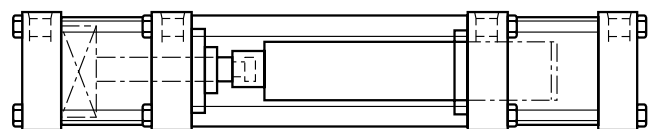

Pumping Units

Pumping units consist of a standard hydraulic cylinder coupled with a volume displacing lance cylinder via tie-bars. Special seals and lance surface treatments are available to provide compatibility with resins and chemicals used in the pumping process. Single and double ended designs are available.

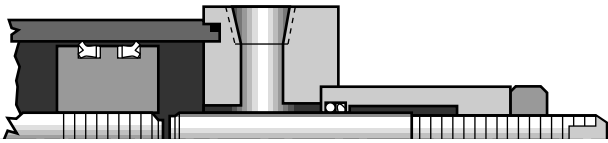

Adjustable Stroke Cylinders

Adjustable stroke cylinders are furnished with a stroke adjusting screw in the cap end of the cylinder. Adjusting this screw in or out limits the retract stroke to the precise length desired.

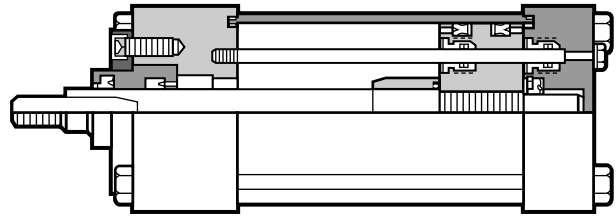

Non-Rotating Cylinders

Non-rotating cylinders are furnished with internal guide rods which prevent piston rod rotation throughout the stroke. Rotational torque and stroke length determine the amount and diameter of the guide rods.

Custom Cylinders

Eaton's full line of cylinder products and options fit most customers' application requirements, however, a special cylinder is often required to meet custom specifications. These custom cylinders are often needed to solve difficult application problems, upgrade existing equipment or are designed into new machinery.

Eaton's Sales, Engineering and Manufacturing groups are cylinder specialists and have many years of experience in the interpretation of requirements, design and manufacture of custom cylinder products.

Our capabilities include:

- Bore diameters to 760mm
- Stroke lengths to 7600mm
- Operating pressures to 700 bar or higher
- Operating mediums ranging from shop air to nitrogen, or from standard hydraulic fluid to special synthetic fluids
- Tie rod, welded, threaded, and bolted cylinder construction
- Finite element analysis
- Application simulation in our testing laboratories



Eaton would appreciate an opportunity to submit a proposal to solve your application problem or fulfill your current cylinder requirements. Simply copy and complete the Application Data Sheet on the following page and fax to Eaton or an authorized Hydro-Line distributor.

HYDRO-LINE Actuation Products



N5 SERIES CYLINDERS

- NFPA interchangeable
- N5–3000 psi nominal hydraulic
- AN5 – to 250 psi very heavy-duty pneumatic
- LAN5 – to 250 psi very heavy-duty pneumatic – permanently lubricated
- All steel construction



R5 SERIES CYLINDERS

- NFPA interchangeable
- A5/R5 – to 250 psi pneumatic
- LA5/LR5 – to 250 psi pneumatic – permanently lubricated
- HA5 – to 400 psi hydraulic
- HR5 – 1500 psi nominal hydraulic



HM SERIES CYLINDERS

- Conform to international metric specifications ISO 6020/2 and DIN 24 554
- 25 mm to 200 mm bore sizes
- 210 BAR nominal hydraulic
- All steel construction



ROCKFORD SERIES CYLINDERS

- ASAE interchangeable agricultural cylinders
- Rockford 2500–2500 psi hydraulic
- Rockford 3000–3000 psi hydraulic



SERIES 20/30 BOOSTERS

- Standard series to 5000 psi output
- Custom designs to 20,000 psi

T SERIES AIR/OIL TANKS

All steel construction

Q6T SERIES AIR/OIL TANKS

Aluminum end caps and translucent tubing



ELECTRONIC FEEDBACK CYLINDERS

Hydraulic or pneumatic cylinders which incorporate cylinder position sensing and feedback throughout the stroke. Available in N5, R5, A5, Q6, HM, HW, SM or special cylinders.



HW SERIES CYLINDERS

- Welded construction
- Heavy duty industrial grade
- 3000 psi nominal hydraulic



TSAVER CYLINDERS

- Threaded body construction
- To 250 psi pneumatic
- To 1000 psi nominal hydraulic



SM SERIES CYLINDERS

- Steel mill type construction
- MSM–2000 psi nominal hydraulic
- HSM–3000 psi nominal hydraulic
- ASM–Pneumatic



Q6 SERIES CYLINDERS

- NFPA Interchangeable
- Q6–250 psi pneumatic - permanently lubricated
- HQ6–400 psi hydraulic
- 3/4" to 8" Bores



CUSTOM CYLINDERS

Custom cylinders to meet special requirements

- Bores to 48"
- Strokes to 300"
- Pressures to 10,000 psi or higher

1112 Brooks Street S.E.
Decatur, Alabama 35601
U.S.A.
tel: 256-350-2603
fax: 256-351-1264
www.hydro-line.com

2425 W. Michigan Avenue
Jackson, Michigan 49202
U.S.A.
tel: 517-787-7220
fax: 517-787-3450

7638 Pacific Avenue
White City, Oregon 97503-1091
U.S.A.
tel: 541-826-2131
fax: 541-826-3344

14615 Lone Oak Road
Eden Prairie, MN 55344
USA
Italy
tel: 952 937-9800
fax: 952 974-7722

Eaton Corporation is a global \$8 billion diversified industrial manufacturer that is a leader in fluid power systems; electrical power quality, distribution and control; automotive engine air management and fuel economy; and intelligent truck systems for fuel economy and safety. Eaton's 54,000 employees work in 29 countries on six continents. For more information, visit www.eaton.com.



Fluid Power