



# Vickers

## Load Control Valves

Counterbalance, Vented Counterbalance and Motion Control Valve Packages for applications up to 350 bar (5000 psi) and 190 L/min (50 USgpm)



# Section Contents

## Load Control Valves

<b>Model</b>	<b>Typical Application Pressure bar (psi)</b>	<b>Rated Flow l/mim (USgpm)</b>	<b>Page</b>
Load Control Valves - Application guidelines, features and benefits .....			H-3
Functional symbols .....			H-5
<b>Counterbalance valves</b>			
CBV1/2-10.....	350 (5000) .....	60 (15) .....	H-6
CBV1/2-12 .....	350 (5000) .....	114 (30) .....	H-8
<b>Vented counterbalance valves</b>			
VCB1-10.....	350 (5000) .....	60 (15) .....	H-10
VCB1-12.....	350 (5000) .....	114 (30).....	H-12
<b>Motion control valves</b>			
MCV1-16.....	210 (3000).....	151 (40) .....	H-14
MCV1-20 .....	210 (3000).....	190 (50) .....	H-16
<b>Dual motion control valve</b>			
MCV2-20 .....	210 (3000).....	190 (50) .....	H-18
<b>Dual motion control valve with load lock</b>			
MCV4-16 .....	210 (3000).....	151 (40).....	H-20

### Note

Pilot operated check valves  
are covered in Section G.

# Section Overview

## Load Control Valves

### Load control valves

Eaton offers a broad range of Vickers load control valving including counterbalance, motion control and pilot operated check valves. The prime function of load controls is to prevent loads from running ahead of pump supply and/or to provide positive load holding. These valves provide precise and stable motion control. Load control valves are ideally suited for moving and positioning systems.

These products include both threaded cartridge and inline housing valves to meet the majority of load control requirements.

### Load control application tips

#### 3-ported counterbalance valves

These valves are used with an open center on/off directional valve for:

- Precise control of overrunning loads
- Protection from pump cavitation
- Preventing actuator from running ahead of the pump supply and
- Providing load holding and hose failure safety

#### Vented (4-ported) counterbalance valves

These valves are used for:

- Precise control of overrunning loads
- Regenerative cylinder circuits
- Meter-out control and providing load holding and hose failure safety with proportional control valves

### Pilot operated check valves

These valves are used:

- For position load locking
- As an alternative to counterbalance valves where neither the overrunning loads or release speed are factors in the application.
- Pilot operated check valves are covered in section G

### Counterbalance cartridges, 3-ported

The CBV are single cartridge type counterbalance valves that have:

- A check feature allowing free flow in one direction
- A relief feature controlling flow in the other direction
- A pilot signal that overrides the relief setting providing the counterbalance function.

The CBV\*-10 series products are capable of handling flows to up 60 L/min (15 USgpm) and pressures up to 350 bar (5000 psi).

The CBV\*-12 series products are capable of handling flows up to 114 L/min (30 USgpm) and pressures up to 350 bar (5000 psi).

These valves are available with 4:1 and 10:1 pilot ratios. As a general rule, a low pilot ratio will provide better motion control and stability in systems with higher capacitance (spongy) and inductance (high inertial loads). A high pilot ratio improves the efficiency of a hydraulic system, but motion control stability may suffer.

The 3-ported counterbalance valves are offered with a wide variety of standard housings with SAE and BSPP port options. Aluminum and steel housings are available in the following styles:

- Inline single
- Inline dual
- Inline dual, with integral shuttle
- SAE 4-bolt, Code 61
- Close coupled, nipple mounted
- Gasket mounted single
- Gasket mounted dual
- Various bolt on manifolds for Eaton hydraulic motors

### Vented counterbalance cartridges, 4-ported

The VCB1-10 and VCB1-12 are single cartridge type counterbalance valves that have:

- A check feature that allows free flow in one direction
- A relief feature that controls flow in the other direction and
- A pilot signal that overrides the relief setting, providing the counterbalance function

The additional 4th port on this valve provides an external drain that makes the valve insensitive to back pressure at port 2, when the valve is piloted open. This is particularly useful in regenerative circuits, meter-out circuits, servo valves and proportional valves circuits. This valve is available with a 4:1 pilot ratio. The

4-ported counterbalance valve is offered with a wide variety of standard housings with SAE and BSPP port options.

NOTE: For applications where the flow rate will not exceed 37,8 L/min (10 USgpm) for VCB1-10 and 95 L/min (25 USgpm) for VCB1-12, the standard C-\*\*-4 housing can be used. For applications over those flows or those that require a reduced pressure drop, housings with the slot feature or a C-\*\*-4U cavity are required.

Aluminum and steel housings are available in the following styles:

- Inline single
- Inline dual
- Gasket mounted single

### Motion control valves

These are inline housing type motion control or counterbalance valves that utilize separate cartridges to perform the counterbalance function as described in the 3-ported version. The 16 and 20 series valves are available in both single and dual functions. The 16 series is capable of handling flows up to 151 L/min (40 USgpm) and pressures up to 210 bar (3000 psi). The 20 series valves are capable of handling 190 L/min (50 USgpm) and pressures up to 210 bar (3000 psi). Both series offer a 10:1 pilot ratio.



## Features and benefits of counterbalance & motion controls:

- Positive load holding in any position.
- Thermal expansion relief protection.
- Cartridge valves may be installed directly into cavities machined in the actuator body. This reduces the number of potential leak points and simplifies plumbing.
- Line mounting of single or dual functions can simplify installation of load control valves in many applications.
- Dual function models that can introduce low-pressure makeup flow to prevent cavitation can be line mounted in hydrostatic transmissions.
- When used with paired cylinders, counterbalance valves will help to balance the load by transferring part of the load from the heavily loaded cylinder to the less loaded cylinder.
- When used with an open center directional control valve, deceleration control can be provided.

## Adjusting counterbalance cartridge valve pressure setting:

Counterbalance valves adjust in the opposite direction of other pressure control valves. Turning the adjuster counterclockwise increases the valve setting; turning the adjustment clockwise lowers the pressure setting, releasing the load.

1. Loosen the jam nut.
2. Turn the adjusting screw clockwise to reduce the pressure setting, or counterclockwise to increase the pressure setting.

## Do not remove the spring wire from the adjusting screw.

3. Tighten the jam nut to secure the desired pressure setting.

NOTE CBV\*-10 spring wire must not be removed. Removal will affect the minimum adjustment of the valve.



### CAUTION

Care should be taken to ensure the load is supported by mechanical means when servicing or removing the cartridge valve.



### CAUTION

Hydraulically released "dead-man" brakes should be used to lock static loads due to motor and cylinder leakage.



### CAUTION

Counterbalance valves can be damaged by severe decompression shock. To help prevent shock damage, a restriction may be added between the cylinder and the counterbalance valve.



### CAUTION

Counterbalance valves are not relief valves or energy-saving devices. Stability problems may be encountered when system operating pressure goes below 50 bar (700 psi).

## Pilot operated check valves

The POC\*-10 and POC\*-12 series of pilot-to-open check valves complement the CBV\*-10 and CBV\*-12 counterbalance cartridges and are physically interchangeable with them. The POC's provide a low cost alternative to load control when the dynamics of neither overrunning loads nor load release speed are factors to be considered in the design of the hydraulic circuit for the load to be controlled.

The pilot-to-open valves positively lock a load from port 1 to port 2 until pilot pressure applied to port 3 is sufficient to unseat the valve. This then permits flow from port 1 to port 2. The load can also be released through means of an optional screw type override.

The POC\*-10 covers flow up to 60 L/min (15 USgpm). The POC\*-12 covers flow up to 114 L/min (30 USgpm). With infinite life qualification to a fatigue pressure rating of 310 bar (4500 psi), these POC valves are suitable for use in a broad range of load control applications with typical system operating pressures up to 350 bar (5000 psi). Tailoring of the circuit to gain energy savings while minimizing shock is obtained through the use of several standard cracking pressure ranges from 2,0 bar (30 psi) to 7 bar (100 psi). When anti-cavitation protection is required, the 0,30 bar (5 psi) spring should be used. For those applications where pilot pressure may not always be available, the valve can be ordered with an optional adjustable override.

Pilot-to-open valves are suitable for a wide range of applications including aerial work platforms, boom truck, machine tool and round bailer markets.

**Pilot operated check valves are covered in section G.**

## Features and benefits of pilot operated check valves:

- Simple load holding device. Low cost alternative to more complex solutions when overrunning loads are not present and / or control of load release speed is not required.
- Provides high operational efficiency and low spring settings.
- Valves are offered with a wide variety of standard

housings with SAE and BSPP port options in the following configurations:

- Inline single
- Inline dual
- SAE, 4-bolt
- Close coupled, nipple mounted
- Gasket mounted single
- Gasket mounted dual

These valves fit into C\*-3S cavities.

- Four standard cracking pressures permit energy savings, while tailoring the hydraulic system requirements to minimize shock.
- Unique dual spring design provides high operational efficiency and a low pressure spring option for effective anti-cavitation protection.
- Unique design provides compact package and low pressure drops that match or exceed current market expectations and provide for excellent repeatability and stability.
- 3:1 pilot ratio satisfies simple load holding application requirements, while providing smooth operation and longer operating life.
- Optional adjustable override releases the load for situations where pilot pressure is not always available.



### WARNING

Do not use Pilot-to-open check valves in load

holding applications where either overrunning loads are possible or load release speed is critical. Failure to observe these guidelines may result in bodily injury or damage to equipment.

### WARNING



For pressure over 210 bar (3000 psi) use steel housings.

# Functional Symbols

load Control Valves

## CBV cartridges in housings

I - Inline Mounted

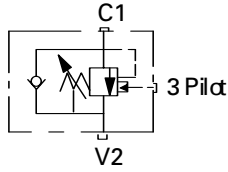

B - 4-Bolt Pad (Size 12 only)

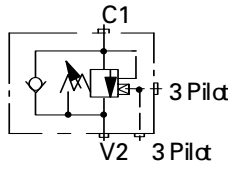

N - Closed Coupled, Nipple Mounted

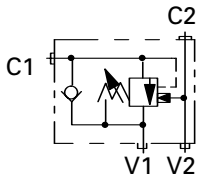

G - Gasket Mounted, Single

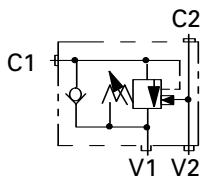

D - Dual Line Mounted

P - Dual Gasket Mounted

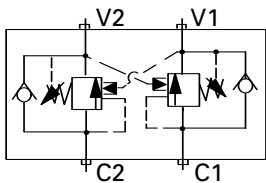

H - Dual, bolt on for H or T motor

2K - Dual, bolt on for 2000 series motor

M - Dual Counterbalance Line Mounted w/Integral Shuttle

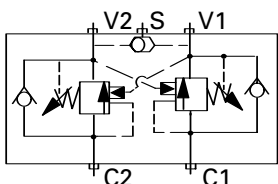

## VCB cartridges in housings

I - Inline Mounted

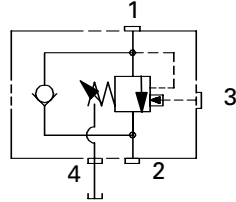

G - Gasket Mounted, Single

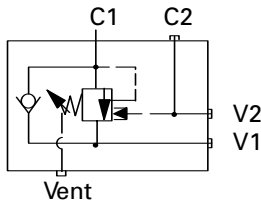

D - Dual Line Mounted

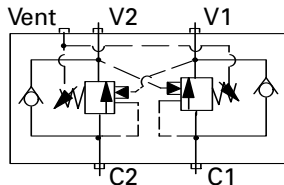

## POC cartridges in housings\*

I - Inline Mounted

F Type

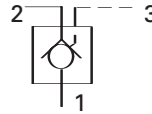

S Type

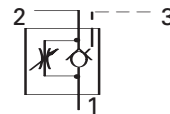

B - 4-Bolt Pad (Size 12 only)

F Type

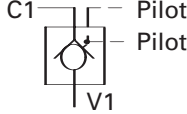

S Type

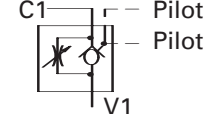

N - Close Coupled, Nipple Mounted

F Type

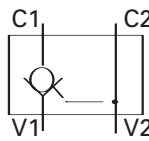

S Type

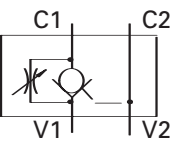

G - Gasket Mounted, Single

F Type

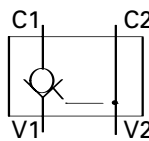

S Type

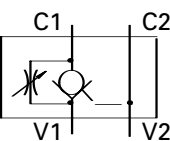

D - Dual Line Mounted

F Type

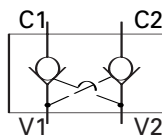

S Type

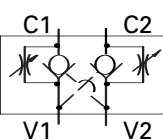

P - Dual Gasket Mounted

F Type

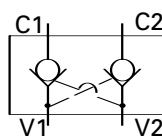

S Type

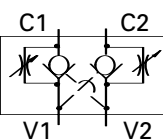

\* Pilot operated check valve data sheets are included in Section G

H

# CBV1/2-10

Counterbalance valve

## Description

The CBV\*-10 is a 3-ported, externally piloted, screw-in cartridge type counterbalance valve.

## Operation

The CBV counterbalance valve allows free flow from port 2 (inlet) to port 1 (load).

Flow from port 1 to port 2 is blocked until either the predetermined pressure

setting has been reached or sufficient pilot pressure has been applied to port 3 (pilot).

## Functional Symbol

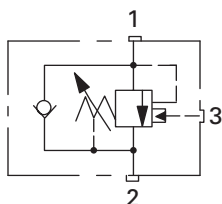

## Sectional View

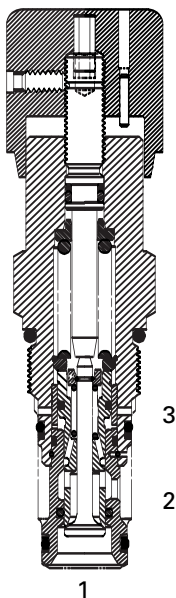

## RATINGS AND SPECIFICATIONS

Performance data is typical with fluid at 21,8 cSt (105 SUS) and 49°C (120°F)

Typical application pressure (all ports)	350 bar (5000 psi)
Cartridge fatigue pressure (infinite life)	350 bar (5000 psi)
Rated flow	60 L/min (15 USgpm)
Cracking pressure @ 1 L/min (0.25 USgpm)	<b>30</b> - 62-210 bar (900-3000 psi) <b>50</b> - 186-350 bar (2700-5000 psi)
Internal leakage	5 drops/min. max. Port 1 to Port 2 @ 77% of crack pressure
Temperature range	-40° to 120°C (-40° to 248°F)
Cavity	C-10-3S
Pilot ratio	4:1, 10:1
Fluids	All general purpose hydraulic fluids such as: MIL-H-5606, SAE 10, SAE 20, etc.
Filtration	Cleanliness code 18/16/13
Standard housing materials	Aluminum or steel
Weight cartridge only	0,23 kg. (0.50 lbs.)
Seal kit	02-173019 Buna-N 02-173020 Viton®

Viton is a registered trademark of E.I. DuPont



### CAUTION

Adjustments exceeding 350 bar (5000 psi) may damage the body.



### WARNING

For pressure over 210 bar (3000 psi) use steel housing.

## Pressure Drop Curves

Cartridge only

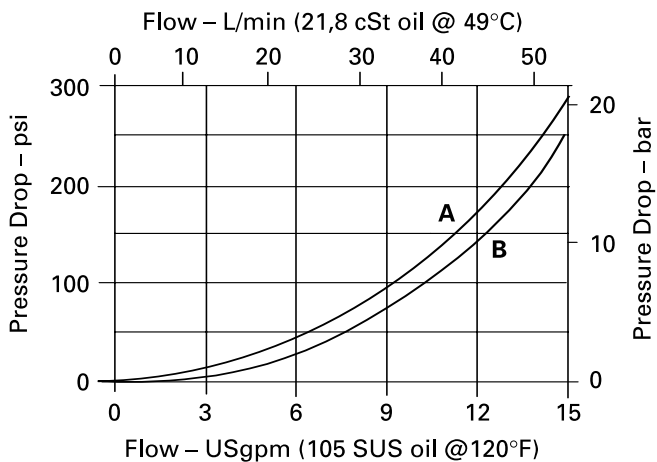

**A** - Piloted open port 1 to port 2  
**B** - Free flow port 2 to port 1

### For 4:1 Ratio

$$\text{Pilot pressure,} = \frac{\text{Cracking pressure} + (5 \times \text{Port 2 pressure}) - \text{Port 1 pressure}}{4}$$

### For 10:1 Ratio

$$\text{Pilot pressure,} = \frac{\text{Cracking pressure} + (11 \times \text{Port 2 pressure}) - \text{Port 1 pressure}}{10}$$



# Model Code

CBV1/2-10

## CBV\* - 10 (V) - \* - \* - \* - \* - \* - \* - \* - \* - \* - 00

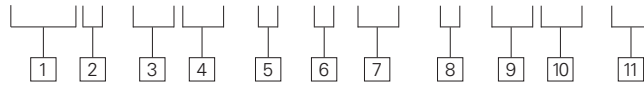

### 1 Valve function

**CBV** - Counterbalance valve

### 2 Pilot ratio

**1** - 4:1  
**2** - 10:1

### 3 Valve size

**10** - Size 10

### 4 Seals

**Blank** - Buna-N  
**V** - Viton

### 5 Adjustment options

**S** - Screw with locknut  
**C** - Cap over screw  
**K** - Hand knob

### 6 Valve Body

**O** - Cartridge only  
**I** - Inline body  
**N** - Close coupled, nipple mounting  
**G** - Gasket mounted, single line mounted  
**D** - Dual counterbalance, line mounted  
**M** - Dual counterbalance, line mounted with integral shuttle valve  
**P** - Dual counterbalance, gasket mounted  
**H** - Dual counter balance, bolt on manifold for H or T series motor  
**2K** - Dual counter balance, bolt on manifold for 2000 series motor

### 7 Housing port sizes

#### PORT SIZE VALVE BODY CODES

PORT SIZE	I Aluminum Steel		N/G/P Aluminum Steel		D/M Aluminum Steel		H/2K Aluminum
	A6H*	S6T	A6H	A6T	A6H	S6T	-
SAE 6	A6H*	S6T	A6H	A6T	A6H	S6T	-
SAE 8	A8H	S8T	-	-	A8H	S8T	-
SAE 10	-	S10T	-	-	A10H	S10T	A10H
1/4" BSPP	A2G	-	-	-	A2G	S2G	-
3/8" BSPP	A3G*	S3G	A3G	A3G	A3G	S3G	-
1/2" BSPP	-	S4G	-	-	A4G	S4G	-

\* Light Duty Housing is available, to specify, substitute H or G with T or B respectively.  
For housing part numbers and dimensions see section J.  
Note -P,H, 2K, D and M bodies contain two CBV valves.

### 8 Free flow crack pressure

**A** - 1,4 bar (20 psi) (standard)  
**B** - 0,28 bar (4 psi) (anti cavitation)  
**C** - 1.4 bar (20 psi) with low leak pilot \*  
**D** - 0.28 bar (4 psi) with low leak pilot \*

\* Low leak pilot is only available on CBV2-\*\*.

Only apply B and D options if required in your application, these are not preferred options.

CBV Valves should not be applied with closed center directional valves.

### 9 Pressure range

**30** - 62-210 bar (900-3000 psi)  
**50** - 186-350 bar (2700-5000 psi)

### 10 Pressure setting (optional)

(Specified by customer in 100 psi increments) for example:  
**20** - 140 bar (2000 psi)  
**35** - 240 bar (3500 psi)

### 11 Special features

**00** - None  
(Only required if valve has special features, omit if 00)  
**SS** - 316 Stainless Steel external components

Note: SS option available only for CBV1-10

## Dimensions

mm (inch)

"C" Adjustment (Cap over screw)

"K" Adjustment (Hand knob)

"S" Adjustment (Screw w/locknut)

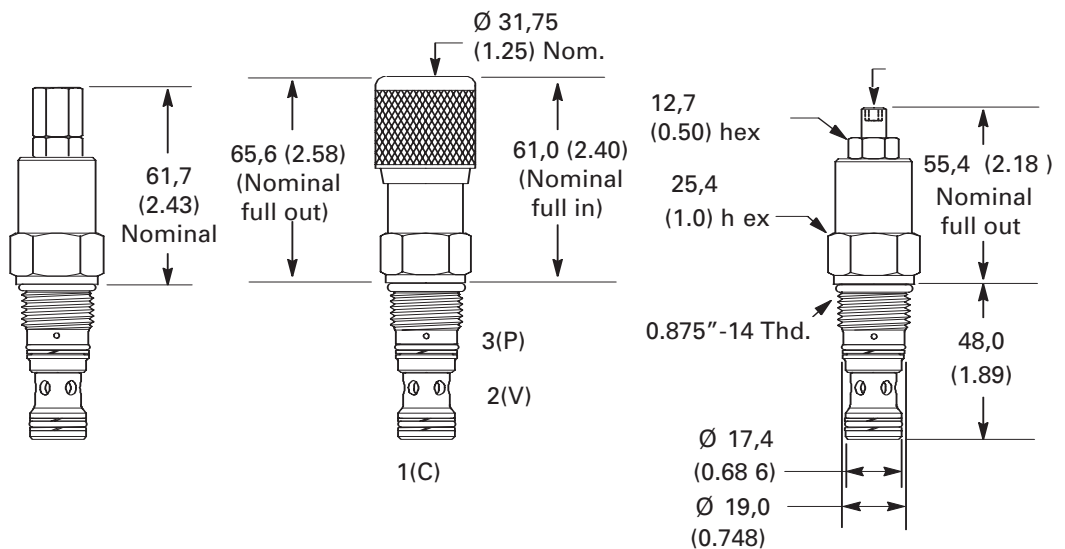

Torque cartridge in housing:

**A** - 47-54 Nm (35-40 ft.lbs)  
**S** - 68-75 Nm (50-55 ft.lbs)

Note

Turn screw or knob clockwise to reduce pressure setting and release load.

# CBV1/2-12

Counterbalance valve

## Description

The CBV\*-12 is a 3-ported, externally piloted, screw-in cartridge type counterbalance valve.

## Operation

The counterbalance valve allows free flow from port 2 to port 1. Flow from port 1

to port 2 is blocked until either the predetermined pressure setting has been

reached or sufficient pilot pressure has been applied to port 3 (pilot).

## Functional Symbol

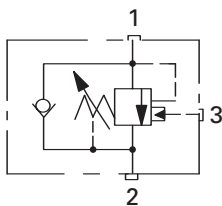

## Sectional View

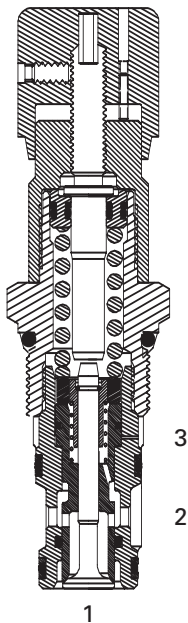

## RATINGS AND SPECIFICATIONS

Performance data is typical with fluid at 21,8 cSt (105 SUS) and 49°C (120°F)

Typical application pressure (all ports)	350 bar (5000 psi)
Cartridge fatigue pressure (infinite life)	350 bar (5000 psi)
Rated flow	114 L/min (30 USgpm)
Cracking pressure @ 1 L/min (0.25 USgpm)	<b>30</b> - 62-210 bar (900-3000 psi) <b>50</b> - 186-350 bar (2700-5000 psi)
Internal leakage	5 drops/min. max. Port 1 to Port 2 @ 77% of crack pressure
Temperature range	-40° to 120°C (-40° to 248°F)
Cavity	C-12-3S
Pilot ratio	4:1, 10:1
Fluids	All general purpose hydraulic fluids such as: MIL-H-5606, SAE 10, SAE 20, etc.
Filtration	Cleanliness code 18/16/13
Standard housing materials	Aluminum or steel
Weight cartridge only	0,36 kg. (0.79 lbs.)
Seal kit	02-180095 Buna-N 02-165887 Viton®

Viton is a registered trademark of E.I. DuPont

## Pressure Drop Curves

Cartridge only



**WARNING**  
For pressure over 210 bar (3000 psi) use steel housing.



**CAUTION**  
Adjustments exceeding 350 bar (5000 psi) may damage the body.

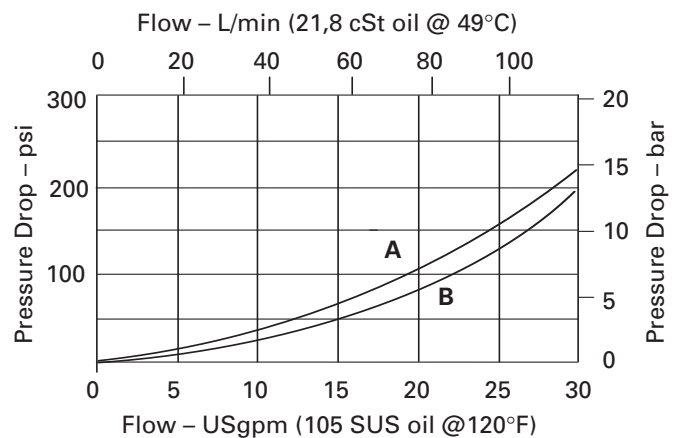

**A** - Piloted open port 1 to port 2  
**B** - Free flow port 2 to port 1

### For 4:1 Ratio

$$\text{Pilot pressure,} = \frac{\text{Cracking pressure} + (5 \times \text{Port 2 pressure}) - \text{Port 1 pressure}}{4}$$

### For 10:1 Ratio

$$\text{Pilot pressure,} = \frac{\text{Cracking pressure} + (11 \times \text{Port 2 pressure}) - \text{Port 1 pressure}}{10}$$



# Model Code

CBV1/2-12

## CBV\* - 12 (V) - \* - \* \* \* \* - \* - \*\*/\*\* - 00

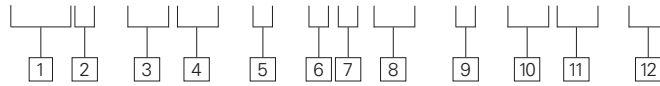

### 1 Valve function

**CBV** - Counterbalance valve

### 2 Pilot ratio

**1** - 4:1

**2** - 10:1

### 3 Valve size

**12** - Size 12

### 4 Seals

**Blank** - Buna-N

**V** - Viton

### 5 Adjustment

**S** - Screw with locknut

**C** - Cap over screw

**K** - Hand knob

### 6 Valve body

**O** - Cartridge only

**I** - Inline body

**B** - SAE 4 - Bolt pad

**N** - Close coupled, nipple mounting

**G** - Gasket mounted, single

**D** - Dual counterbalance, line mounted

**M** - Dual counterbalance, line mounted with integral shuttle valve

**P** - Dual counterbalance, gasket mounted

### 7 Valve housing material

**A** - Aluminum

**S** - Steel

### 8 Housing port sizes

PORT SIZE	VALVE BODY CODES			
	I	B	N/G/P	D/M
SAE 8	-	-	<b>8T</b>	-
SAE 10	<b>10T</b>	-	-	<b>10T</b>
SAE 12	<b>12T</b>	-	-	<b>12T</b>
1/2" BSPP	<b>4G</b>	-	<b>4G</b>	<b>4G</b>
3/4" BSPP	<b>6G</b>	-	-	-
SAE-Code 61	<b>6T</b>			

For housing part numbers and dimensions see section J.

### 9 Free flow crack pressure

**A** - 2,0 bar (25 psi) (standard)

**B** - 0,30 bar (4 psi) (anti-cavitation)

**C** - 1.4 bar (20 psi) with low leak pilot \*

**D** - 0.28 bar (4 psi) with low leak pilot \*

\* Low leak pilot is only available on CBV2-\*\*\*.

Only apply B and D options if required in your application, these are not preferred options.

CBV Valves should not be applied with closed center directional valves.

### 10 Pressure range

**30** - 62-210 bar (900-3000 psi)

**50** - 186-350 bar (2700-5000 psi)

### 11 Pressure setting (optional)

(Specified by customer in 100 psi increments) for example:

**20** - 140 bar (2000 psi)

**35** - 240 bar (3500 psi)

### 12 Special features

**00** - None

(Only required if valve has special features, omit if 00)

### Dimensions

mm (inch)

Torque cartridge in housing:

**A** - 81-95 Nm (60-70 ft.lbs)

**S** - 102-115 Nm (75-85 ft.lbs)

"C" Adjustment

"K" Adjustment

"S" Adjustment

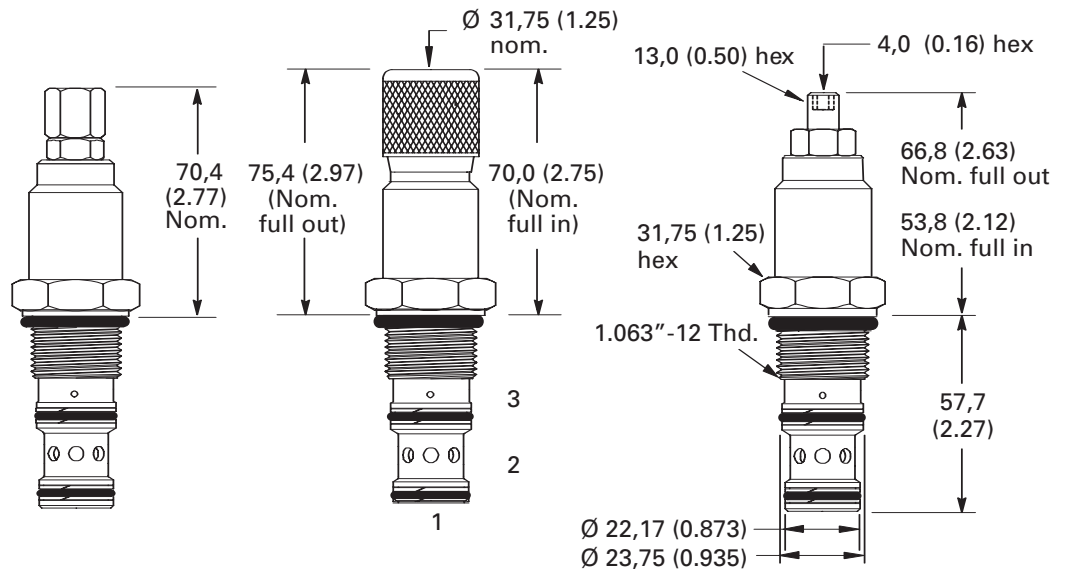

### Note

Turn screw or knob clockwise to reduce pressure setting and release load.

# VCB1-10

Vented counterbalance valve

## Description

The VCB1-10 is a 4-ported, externally piloted, screw-in cartridge type counterbalance valve with the separate vent. This separate vent makes the valve insensitive to back pressure at port 2.

## Operation

The VCB1-10 counterbalance valve will allow free flow from port 2 to port 1 through a built in check valve. Flow

from port 1 to port 2 is blocked until either a predetermined pressure setting has been reached or

sufficient pilot pressure has been sensed on port 3 (pilot). Port 4 is vented to tank.

## Functional Symbol

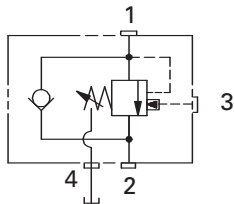

## Sectional View

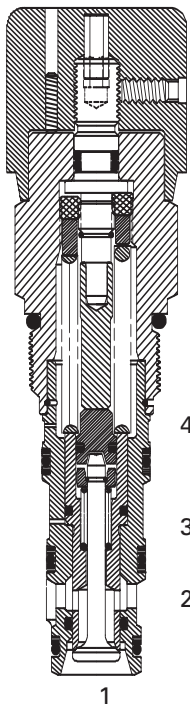

## RATINGS AND SPECIFICATIONS

*Performance data is typical with fluid at 21,8 cSt (105 SUS) and 49°C (120°F)*

Typical application pressure (all ports)	350 bar (5000 psi)
Cartridge fatigue pressure (infinite life)	350 bar (5000 psi)
Rated flow	60 L/min (15 USgpm)
Cracking pressure @ 1 L/min (0.25 USgpm)	<b>30 - 62-210 bar (900-3000 psi)</b> <b>50 - 186-350 bar (2700-5000 psi)</b>
Internal leakage	5 drops/min. max. Port 1 to Port 2 @ 77% of crack pressure
Temperature range	-40° to 120°C (-40° to 248°F)
Cavity	C-10-4 or C-10-4U
Pilot ratio	4:1
Fluids	All general purpose hydraulic fluids such as: MIL-H-5606, SAE 10, SAE 20, etc.
Filtration	Cleanliness code 18/16/13
Standard housing materials	Aluminum or steel
Weight cartridge only	0,36 kg. (0.79 lbs.)
Seal kit	889625 Buna-N 566080 Viton®

*Viton is a registered trademark of E.I. DuPont*

## Pressure Drop Curves

Cartridge only



**WARNING**  
For pressure over 210 bar (3000 psi) use steel housing.



**CAUTION**  
Adjustments exceeding 350 bar (5000 psi) may damage the body.

Note

Valve should be set 1.3 times load induced pressure.

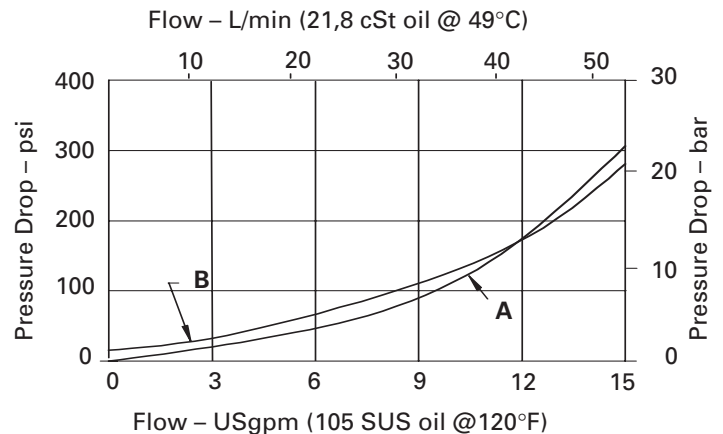

**A** - Piloted open port 1 to port 2  
**B** - Free flow port 2 to port 1

## For 4:1 Ratio

$$\text{Pilot pressure} = \frac{\text{Crack pressure} - \text{Load pressure}}{\text{Pilot ratio}}$$

# Model Code

VCB1-10

## VCB1 – 10 (V) – \* – \* \*\*\*\* – \* – \*\*/\*\* – 00

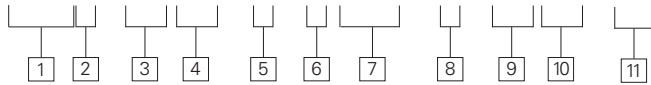

### 1 Valve function

**VCB** - Vented counterbalance valve

### 2 Pilot ratio

**1** - 4:1

### 3 Valve size

**10** - Size 10

### 4 Seals

**Blank** - Buna-N  
**V** - Viton

### 5 Adjustment

**S** - Screw with locknut  
**C** - Cap over screw  
**K** - Hand knob

### 6 Valve body

**O** - Cartridge only  
**I** - Inline body  
**G** - Gasket mounted, single  
**D** - Dual counterbalance, line mounted

### Dimensions

mm (inch)

Torque cartridge in housing:  
**A** - 47-54 Nm (35-40 ft.lbs)  
**S** - 68-75 Nm (50-75 ft.lbs)

### Note

Turn screw or knob clockwise to reduce pressure setting and release load.

### 7 Housing port sizes

PORT SIZE	VALVE BODY CODES					
	I Alum.	Steel	D Alum.	Steel	G Alum.	Steel
SAE 6	<b>A6H*</b>	<b>S6T</b>	<b>A6H</b>	<b>S6T</b>	<b>A6H</b>	<b>S6T</b>
SAE 8	<b>A8H**</b>	<b>S8T**</b>	<b>A8H**</b>	<b>S8T**</b>	<b>A8H**</b>	<b>S8T**</b>
SAE 10	<b>A10H**</b>	-	-	<b>S10T</b>	-	-
1/4" BSPP	<b>A2G</b>	-	-	-	-	-
3/8" BSPP	<b>A3G**</b>	<b>S3G**</b>	<b>A3G**</b>	<b>S3G**</b>	<b>A3G</b>	<b>S3G**</b>

\* Light Duty Housing is available, to specify, substitute H with T respectively.

\*\*Housings with slot.

Note - for housing part numbers and dimensions see section J.

### 8 Free flow crack pressure

**A** - 1,4 bar (20 psi) (standard)  
**B** - 0,28 bar (4 psi) (anti-cavitation)

### 9 Pressure range

**30** - 62-210 bar (900-3000 psi)  
**50** - 186-350 bar (2700-5000 psi)

### 10 Pressure setting (optional)

(Specified by customer in 100 psi increments) for example:  
**20** - 140 bar (2000 psi)  
**35** - 240 bar (3500 psi)

### 11 Special features

**00** - None  
(Only required if valve has special features, omit if 00)

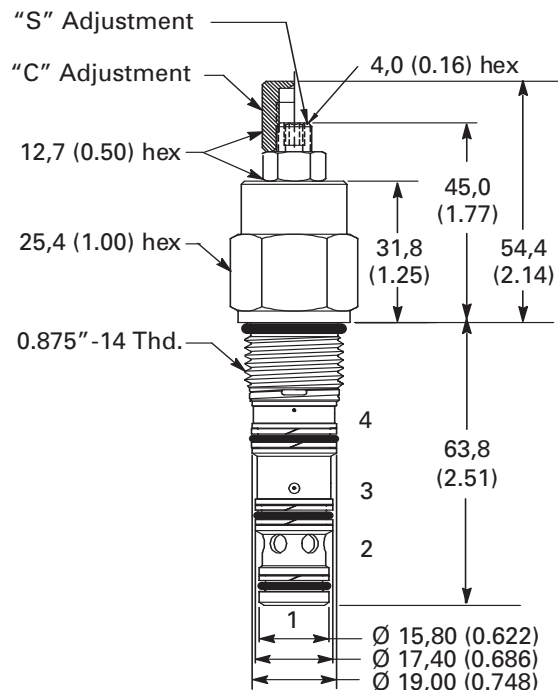
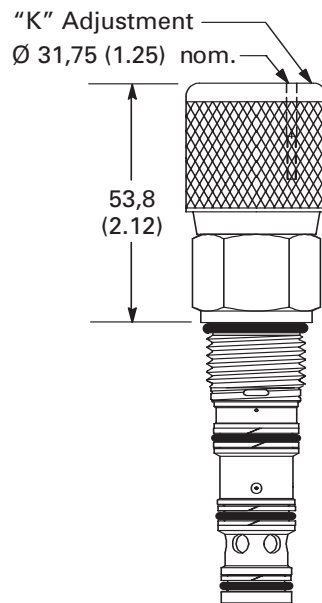

# VCB1-12

Vented counterbalance valve

## Description

The VCB1-12 is a 4-ported, externally piloted, screw-in cartridge type counterbalance valve with the separate vent. This separate vent makes the valve insensitive to back pressure at port 2.

## Functional Symbol

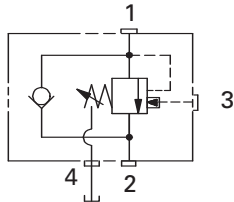

## Sectional View

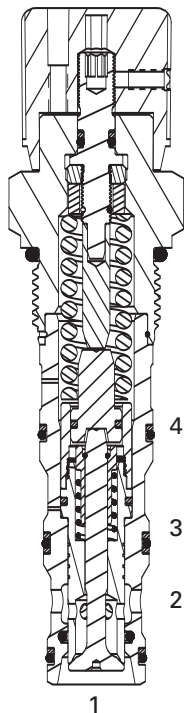

### For 4:1 Ratio

$$\text{Pilot pressure} = \frac{\text{Relief setting} - \text{Load pressure}}{\text{Pilot ratio}}$$

## Operation

The VCB1-12 counterbalance valve will allow free flow from port 2 to port 1 through a built in check valve.

Flow from port 1 to port 2 is blocked until either a predetermined pressure setting has been reached

or sufficient pilot pressure has been sensed on port 3 (pilot). Port 4 is vented to tank.

## RATINGS AND SPECIFICATIONS

*Performance data is typical with fluid at 21,8 cSt (105 SUS) and 49°C (120°F)*

Typical application pressure (all ports)	350 bar (5000 psi)
Cartridge fatigue pressure (infinite life)	350 bar (5000 psi)
Rated flow	114 L/min (30 USgpm)
Cracking pressure @ 1 L/min (0.25 USgpm)	<b>30</b> - 35-210 bar (500-3000 psi) <b>50</b> - 175-350 bar (2500-5000 psi)
Internal leakage	5 drops/min. max. Port 1 to Port 2 @ 77% of crack pressure
Temperature range	-40° to 120°C (-40° to 248°F)
Cavity	C-12-4 or C-12-4U
Pilot ratio	4:1
Fluids	All general purpose hydraulic fluids such as: MIL-H-5606, SAE 10, SAE 20, etc.
Filtration	Cleanliness code 18/16/13
Standard housing materials	Aluminum or steel
Weight cartridge only	0,37 kg. (0.81 lbs.)
Seal kit	02-160979 Buna-N 02-160980 Viton®

*Viton is a registered trademark of E.I. Dupont*

## Pressure Drop Curves

Cartridge only



### WARNING

For pressure over 210 bar (3000 psi) use steel housing.



### CAUTION

Adjustments exceeding 350 bar (5000 psi) may damage the body.

Note  
Valve should be set 1.3 times load induced pressure.

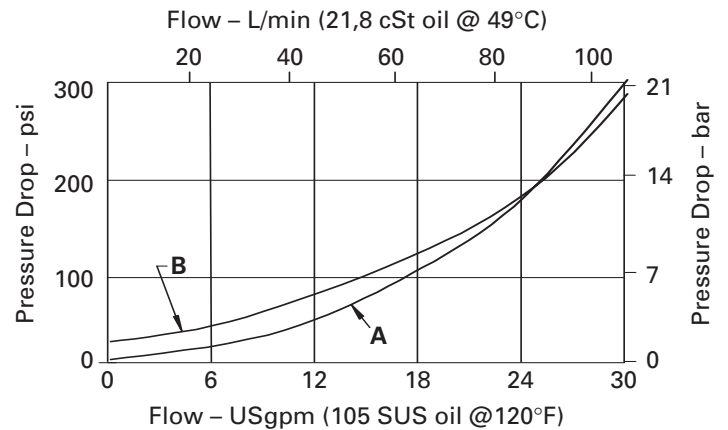

**A** - Piloted open port 1 to port 2  
**B** - Free flow port 2 to port 1

# Model Code

VCB1-12

## VCB1 - 12 (V) - \* - \* \*\*\*\* - \* - \*\*/\*\* - 00

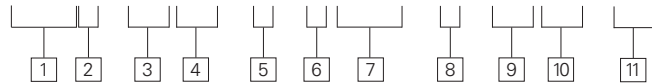

### 1 Valve function

**VCB** - Vented counterbalance valve

### 2 Pilot ratio

**1** - 4:1

### 3 Valve size

**12** - Size 12

### 4 Seals

**Blank** - Buna-N  
**V** - Viton

### 5 Adjustment

**S** - Screw with locknut  
**C** - Cap over screw  
**K** - Hand knob

### 6 Valve Body

**O** - Cartridge only  
**I** - Inline body  
**G** - Gasket mounted, single  
**D** - Dual counterbalance, line mounted

### 8 Free flow crack pressure

**A** - 1,7 bar (25 psi) (standard)  
**B** - 0,28 bar (4 psi) (anti-cavitation)

### 9 Pressure range

**30** - 35-210 bar (500-3000 psi)  
**50** - 175-350 bar (2700-5000 psi)

### 10 Pressure setting (optional)

(Specified by customer in 100 psi increments) for example:  
**20** - 140 bar (2000 psi)  
**35** - 240 bar (3500 psi)

### 11 Special features

**00** - None  
(Only required if valve has special features, omit if 00)

### 7 Housing port sizes

PORT SIZE	VALVE BODY CODES			
	I/D Alum.	Steel	G Alum.	Steel
SAE 8	-	-	<b>A8T**</b>	<b>S8T**</b>
SAE 10	<b>A10T</b>	<b>S10T</b>	-	-
SAE 12	<b>A12T**</b>	<b>S12T**</b>	-	-
3/8" BSPP	-	-	<b>A4G**</b>	<b>S4G**</b>
1/2" BSPP	<b>A4G</b>	<b>S4G**</b>	-	-

\*\*Housing with slot

Note - for housing part numbers and dimensions see section J\*.

## Dimensions

mm (inch)

Torque cartridge in housing:

**A** - 81-95 Nm (60-70 ft.lbs)  
**S** - 102-115 Nm (75-85 ft.lbs)

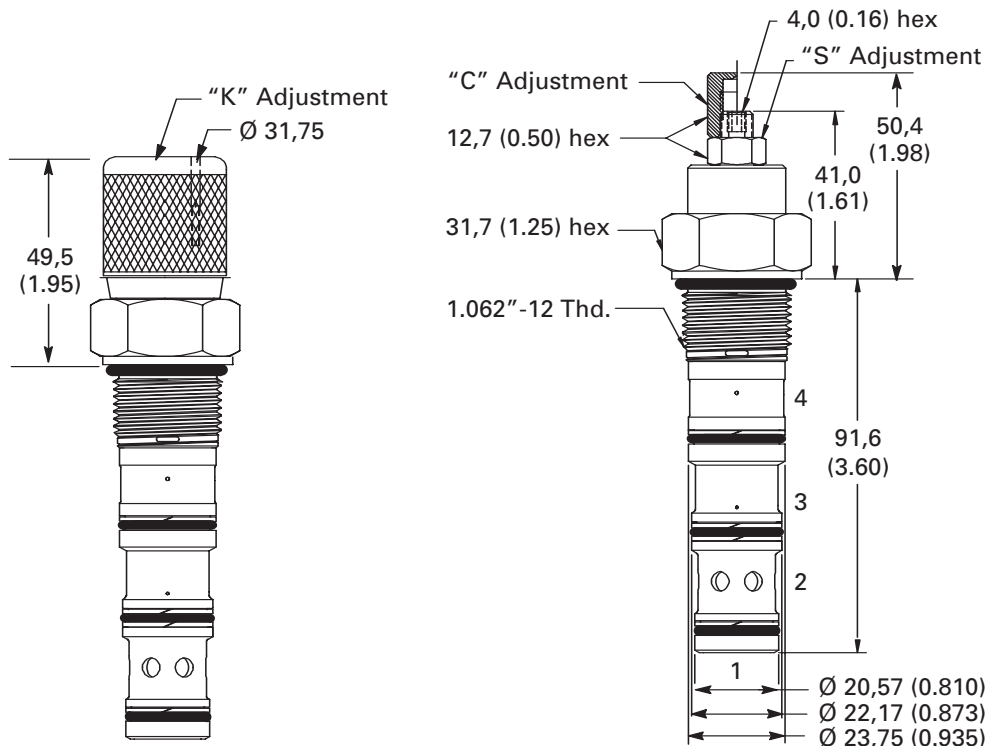

### Note

Turn screw or knob clockwise to reduce pressure setting and release load.

# MCV1-16

Motion control valve

## Description

The MCV1-16 is an inline housing type motion control or load holding valve. This valve controls a moving load and prevents loads from running ahead of a pump. It will also lock or hold a load in any position and provides for thermal expansion relief.

## Operation

The MCV1-16 is an inline housing type motion control valve controls a moving load and prevents loads from running ahead of a pump. It will also lock or hold a load in any position and provides for thermal expansion relief.

## RATINGS AND SPECIFICATIONS

*Performance data is typical with fluid at 21,8 cSt (105 SUS) and 49°C (120°F)*

Typical application pressure (all ports)	210 bar (3000 psi)
Rated flow	151 L/min (40 USgpm)
Free flow cracking pressure @ 1 L/min (0.25 USgpm)	<b>13</b> - 3,4-8,4 bar (50-1300 psi) <b>35</b> - 13,6-240 bar (200-3500 psi)
Internal leakage	<b>Port "C" to "V"</b> less than 5 drops/min. max. @ 210 bar (3000 psi)
Temperature range	-40° to 120°C (-40° to 248°F)
Pilot ratio	11:1
Fluids	All general purpose hydraulic fluids such as: MIL-H-5606, SAE 10, SAE 20, etc.
Filtration	Cleanliness code <b>18/16/13</b>
Standard housing material	Aluminum
Weight	4,50 kg. (10.00 lbs.)
Seal kits (Check valve)	565810 Buna-N 889609 Viton®
Seal kits (Relief valve)	565810 Buna-N 889609 Viton®

*Viton is a registered trademark of E.I. Dupont*

## Functional Symbol

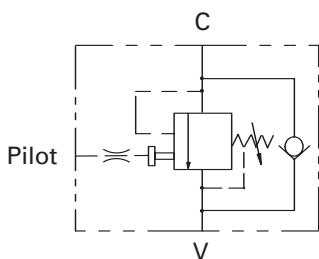

## Sectional View

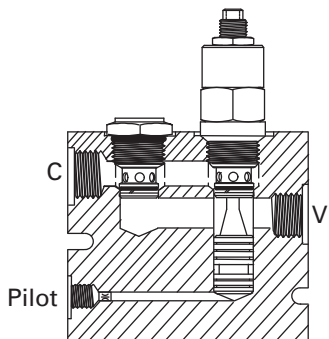

### Pilot pressure calculation for 11:1 Ratio

Nominal pressure to open valve by remote control

Pilot pressure =

Cracking pressure + (12 x Port V pressure) - Port C pressure

11

## Pressure Drop Curves

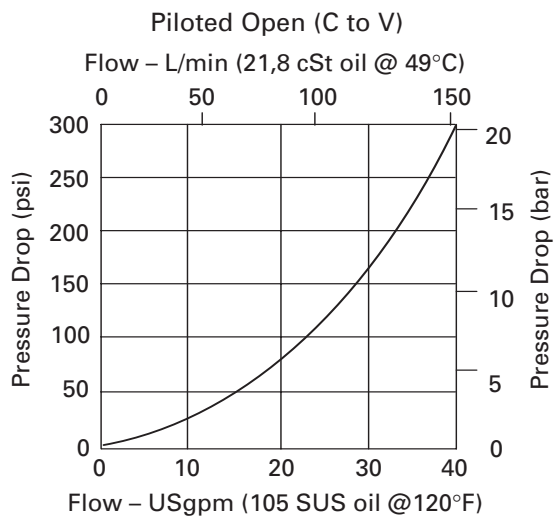
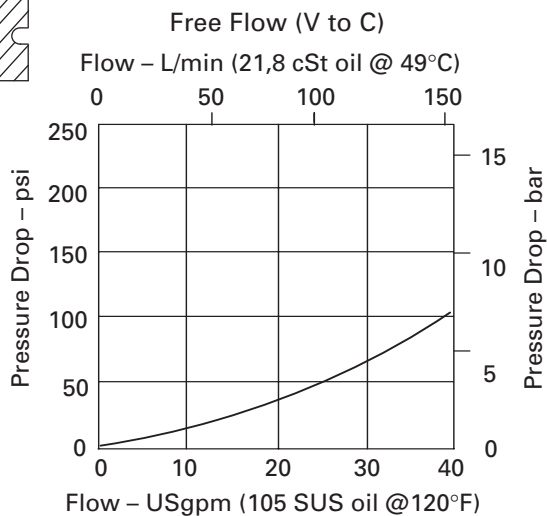



# Model Code

MCV1-16

## MCV1 - 16 (V) - \* - \*\*\* - \*\*/\*\* - 00

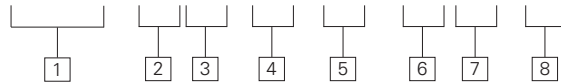

### 1 Valve Function

**MCV1** - Motion control valve

### 2 Size

**16** - 16 Size

### 3 Seals

**Blank** - Buna-N  
**V** - Viton®

### 4 Adjusts

**K** - Hand knob  
**S** - Screw with locknut

### 5 Port size

**12T** - SAE 12 (light duty)  
**6B** - 3/4" BSPP (light duty)

### 6 Cracking pressure range

**13** - 3,4-8,4 bar (50-1300 psi)  
**35** - 13,6-240 bar (200-3500 psi)

### 7 Pressure setting

Optional - specify in 100 psi ranges. If not specified, set at:  
**20** - 140 bar (2000 psi)  
**35** - 240 bar (3500 psi)

### 8 Special features

**00** - None  
(Only required if valve has special features, omit if 00)

## Installation Dimensions

mm (inch)

Torque cartridge in housing  
108-122 Nm (80-90 ft.lbs)

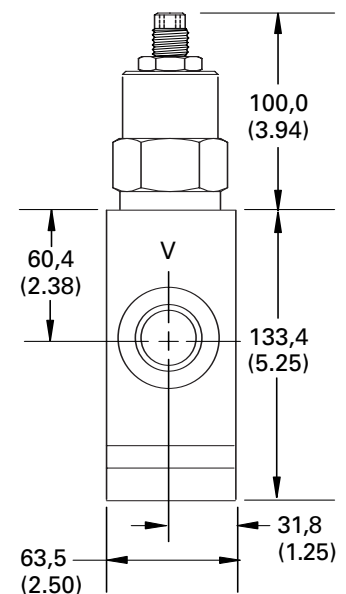
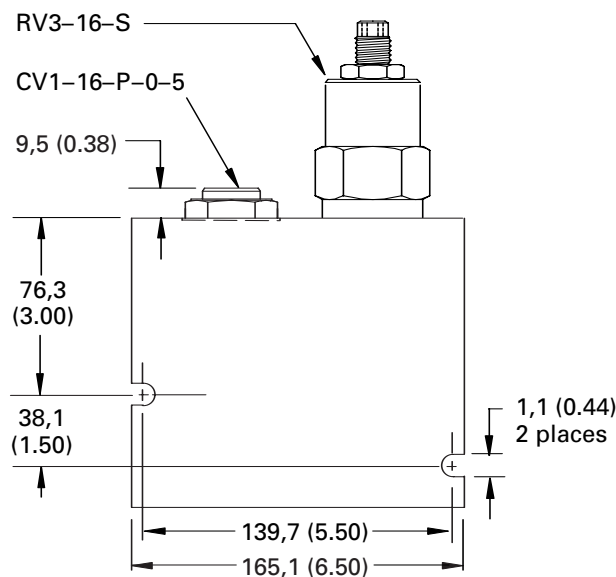
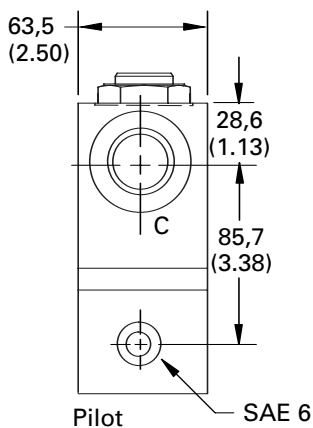
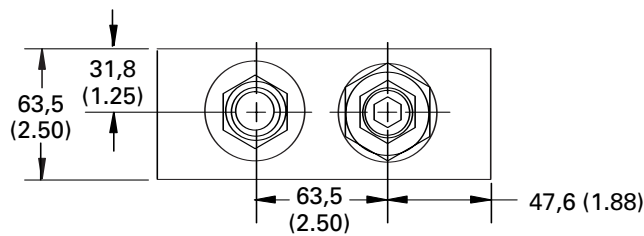

# MCV1-20

Motion control valve

## Description

The MCV1-20 is an inline housing type motion control or load holding valve. This valve controls a moving load and prevents loads from running ahead of a pump. It will also lock or hold a load in any position and provides for thermal expansion relief.

## Operation

This valve allows free flow from the "V" port to the "C" port and blocks flow in the opposite direction until either the relief setting is reached or until sufficient pilot pressure has been applied to the "Pilot" port.

## RATINGS AND SPECIFICATIONS

*Performance data is typical with fluid at 21,8 cSt (105 SUS) and 49°C (120°F)*

Typical application pressure (all ports)	210 bar (3000 psi)
Rated flow	190 L/min (50 USgpm)
Free flow cracking pressure @ 1 L/min (0.25 USgpm)	<b>13</b> - 3,4-8,4 bar (50-1300 psi) <b>35</b> - 13,6-240 bar (200-3500 psi)
Internal leakage	<b>Port "C" to "V"</b> less than 5 drops/min. max. @ 210 bar (3000 psi)
Temperature range	-40° to 120°C (-40° to 248°F)
Pilot ratio	10:1
Fluids	All general purpose hydraulic fluids such as: MIL-H-5606, SAE 10, SAE 20, etc.
Filtration	Cleanliness code <b>18/16/13</b>
Standard housing material	Aluminum
Weight	5,40 kg. (12.00 lbs.)
Seal kits (Check valve)	889615 Buna-N 889619 Viton®
Seal kits (Relief valve)	565810 Buna-N 889609 Viton®

*Viton is a registered trademark of E.I. DuPont*

## Functional Symbol

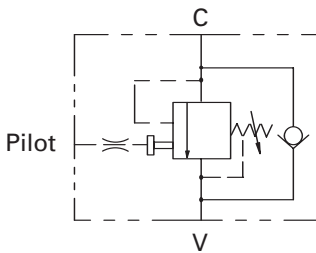

## Sectional View

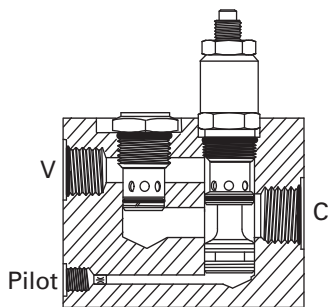

### Pilot pressure calculation for 10:1 Ratio

Nominal pressure to open valve by remote control

$$\text{Pilot pressure} = \frac{\text{Cracking pressure} + (11 \times \text{Port V pressure}) - \text{Port C pressure}}{10}$$

## Pressure Drop Curves

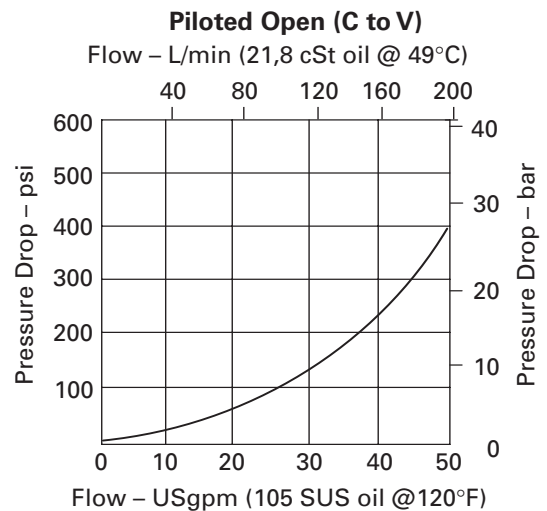
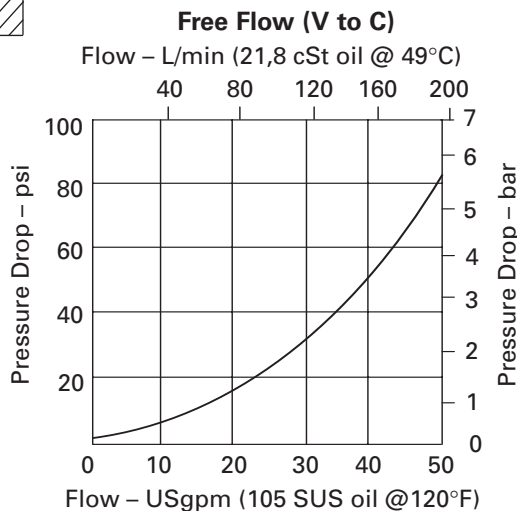

# Model Code

MCV1-20

## MCV1 – 20 (V) – \* – \*\*\* – \*\*/\*\* – 00

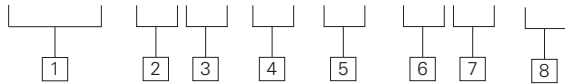

**1 Valve Function**  
**MCV1** - Motion control valve

**2 Size**  
**20** - 20 Size

**3 Seals**  
 Blank - Buna-N  
 V - Viton®

**4 Adjustment**  
**K** - Hand knob  
**S** - Screw with locknut

**5 Port size**  
**16T** - SAE 16 (light duty)  
**8B** - 1" BSPP (light duty)

**6 Cracking pressure range**  
**13** - 3,4-8,4 bar (50-1300 psi)  
**35** - 13,6-240 bar (200-3500 psi)

**7 Pressure setting**  
 Optional - specify in 100 psi ranges. If not specified, set at:  
**20** - 140 bar (2000 psi)  
**35** - 240 bar (3500 psi)

**8 Special features**  
**00** - None  
 (Only required if valve has special features, omit if 00)

### Installation Dimensions

mm (inch)

Torque CV2-20 cartridge in housing 128-155 Nm (95-115 ft.lbs)

Torque RV3-16 cartridge in housing 108-122 Nm (80-90 ft.lbs)

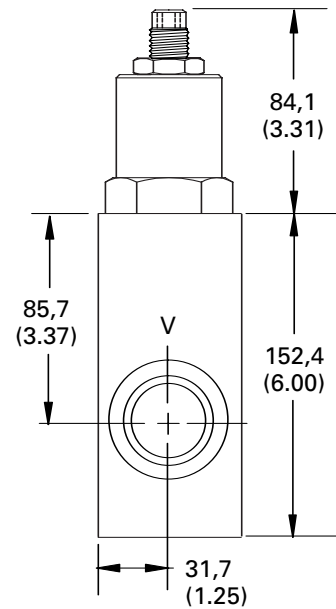
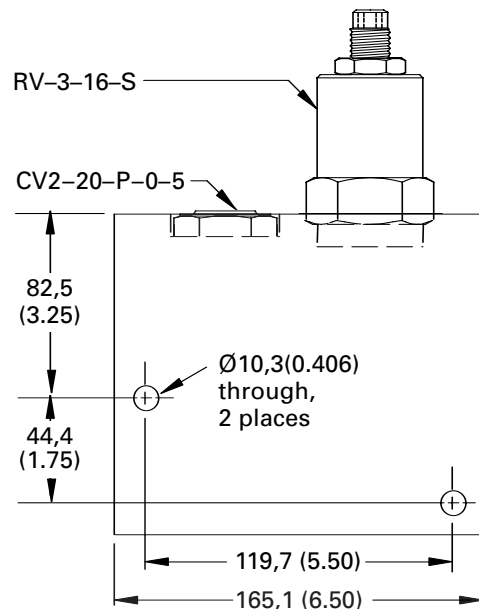
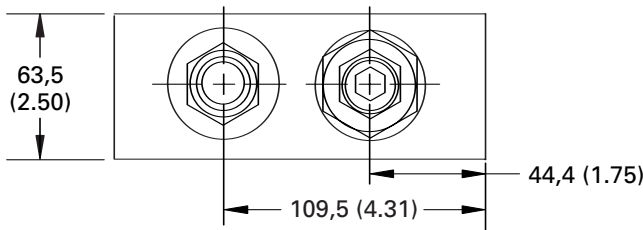
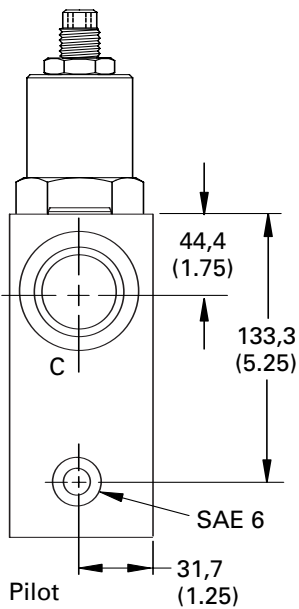

# MCV2-20

Dual-motion control valve

## Description

The MCV2-20 is a dual inline housing type motion control or load holding valve. This valve controls a moving load and prevents loads from running ahead of a pump. It will also lock or hold a load in any position and provides for thermal expansion relief.

## Functional Symbol

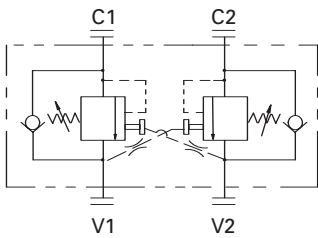

## Sectional View

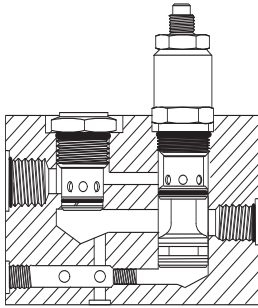

## Operation

This valve allows free flow from the "V" port to the "C" ports and blocks flow in the opposite direction until either the relief setting is reached or until sufficient pilot pressure has been applied from the opposite "V" port.

## RATINGS AND SPECIFICATIONS

*Performance data is typical with fluid at 21,8 cSt (105 SUS) and 49°C (120°F)*

Typical application pressure (all ports)	210 bar (3000 psi)
Rated flow	190 L/min (50 USgpm)
Free flow cracking pressure @ 1 L/min (0.25 USgpm)	<b>13</b> - 3,4-8,4 bar (50-1300 psi) <b>35</b> - 13,6-240 bar (200-3500 psi)
Internal leakage, Port "C" to "V"	less than 5 drops/min. max. @ 210 bar (3000 psi)
Temperature range	-40° to 120°C (-40° to 248°F)
Pilot ratio	10:1
Fluids	All general purpose hydraulic fluids such as: MIL-H-5606, SAE 10, SAE 20, etc.
Filtration	Cleanliness code <b>18/16/13</b>
Standard housing material	Aluminum
Weight	10,0 kg. (21.50 lbs.)
Seal kits (Check valve)	889615 Buna-N 889619 Viton®
Seal kits (Relief valve)	565810 Buna-N 889609 Viton®

*Viton is a registered trademark of E.I. Dupont*

### Pilot pressure calculation for 10:1 Ratio

$$\text{Pilot pressure, nominal at port 3} = \frac{\text{Cracking pressure} + (11 \times \text{Port 2 pressure}) - \text{Port 1 pressure}}{10}$$

## Pressure Drop Curves

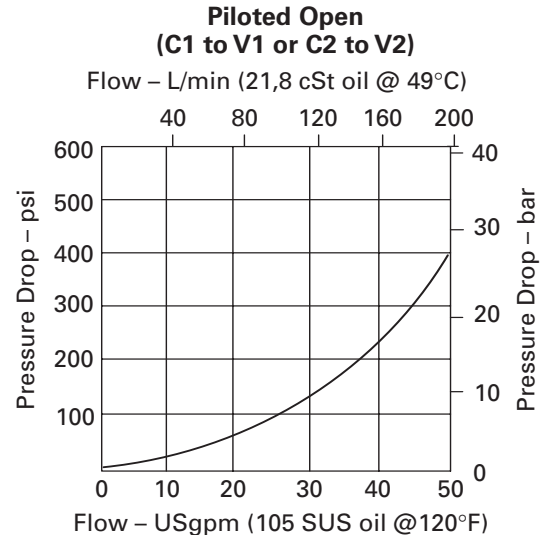
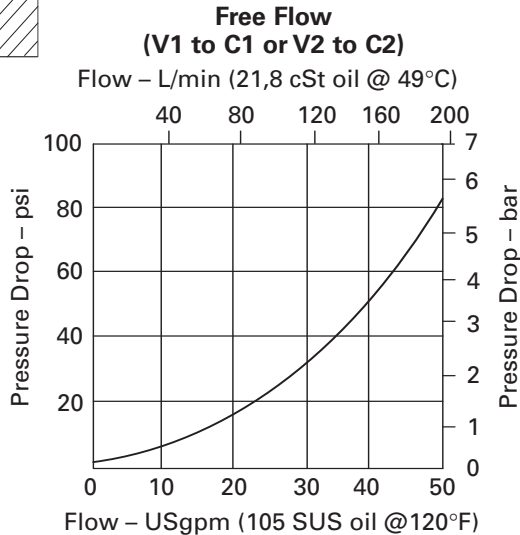

# Model Code

MCV2-20

## MCV2 - 20 (V) - \* - \*\*\* - \*\*/\*\* - 00

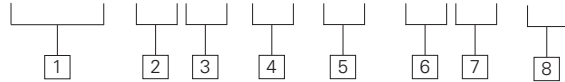

**1 Valve Function**  
**MCV2** - Dual-motion control valve

**2 Size**  
**20** - 20 Size

**3 Seals**  
**Blank** - Buna-N  
**V** - Viton®

**4 Adjustment**  
**K** - Hand knob  
**S** - Screw with locknut

**5 Port size**  
**20T** - SAE 12 (light duty)  
**8B** - 1" BSPP (light duty)

**6 Cracking pressure range**  
**13** - 3,4-8,4 bar (50-1300 psi)  
**35** - 13,6-240 bar (200-3500 psi)

**7 Pressure setting**  
 Optional - specify in 100 psi ranges. If not specified, set at:  
**20** - 140 bar (2000 psi)  
**35** - 240 bar (3500 psi)

**8 Special features**  
**00** - None  
 (Only required if valve has special features, omit if 00)

### Installation Dimensions

mm (inch)

Torque CV2-20 cartridge in housing 128-155 Nm (95-115 ft.lbs)

Torque RV3-16 cartridge in housing 108-122 Nm (80-90 ft.lbs)

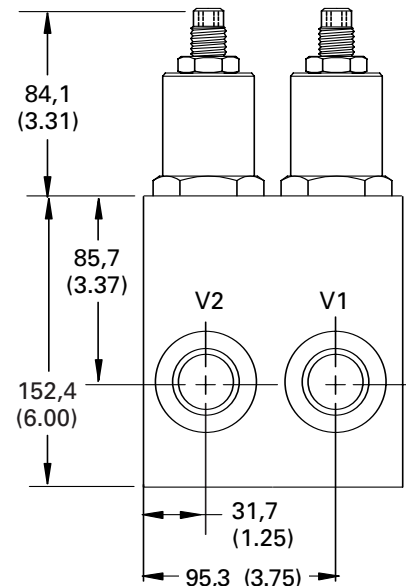
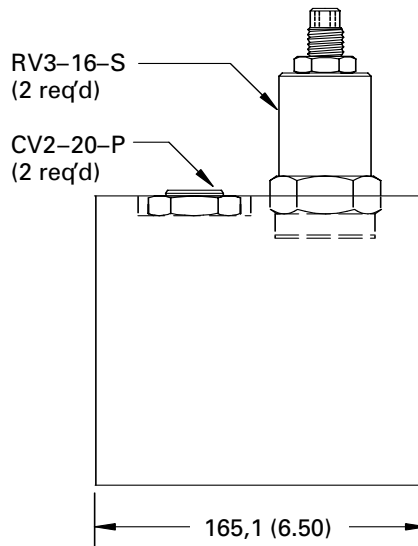
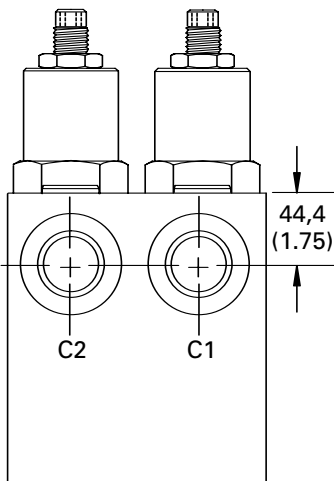
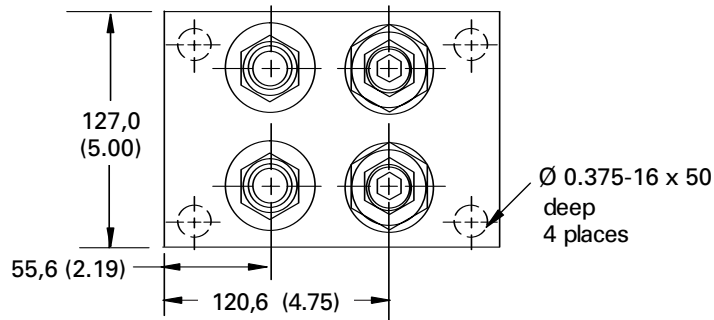

# MCV4-16

Dual-motion control valve

## Description

The MCV4-16 is a dual inline housing type motion control or load holding valve. This valve controls a moving load and prevents loads from running ahead of a pump. It will also lock or hold a load in any position and provides for thermal expansion relief and make-up oil.

## Functional Symbol

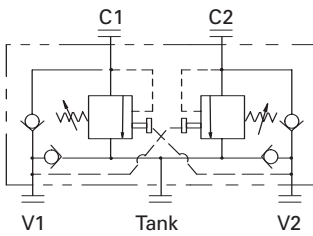

## Sectional View

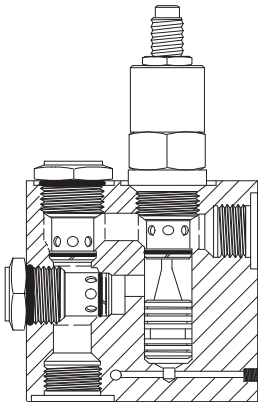

## Operation

This valve allows free flow from the "V" ports to the "C" ports and blocks flow

in the opposite direction until either the relief setting is reached or until sufficient

pilot pressure has been applied from the opposite "V" port.

## RATINGS AND SPECIFICATIONS

*Performance data is typical with fluid at 21,8 cSt (105 SUS) and 49°C (120°F)*

Typical application pressure (all ports)	210 bar (3000 psi)
Rated flow	151 L/min (40 USgpm)
Free flow cracking pressure @ 1 L/min (0.25 USgpm)	<b>13</b> - 3,4-8,4 bar (50-1300 psi) <b>35</b> - 13,6-240 bar (200-3500 psi)
Internal leakage Port "C" to "V"	less than 5 drops/min. max. @ 210 bar (3000 psi)
Temperature range	-40° to 120°C (-40° to 248°F)
Pilot ratio	11:1
Fluids	All general purpose hydraulic fluids such as: MIL-H-5606, SAE 10, SAE 20, etc.
Filtration	Cleanliness code 18/16/13
Standard housing material	Aluminum
Weight	8,0 kg. (18 lbs.)
Seal kits (Check valve)	565810 Buna-N 889609 Viton®
Seal kits (Relief valve)	565810 Buna-N 889609 Viton®

*Viton is a registered trademark of E.I. DuPont*

### Pilot pressure calculation for 11:1 Ratio

Nominal pressure to open valve by remote control

Pilot pressure =

Cracking pressure + (12 x Port V pressure) - Port C pressure

11

## Pressure Drop Curves

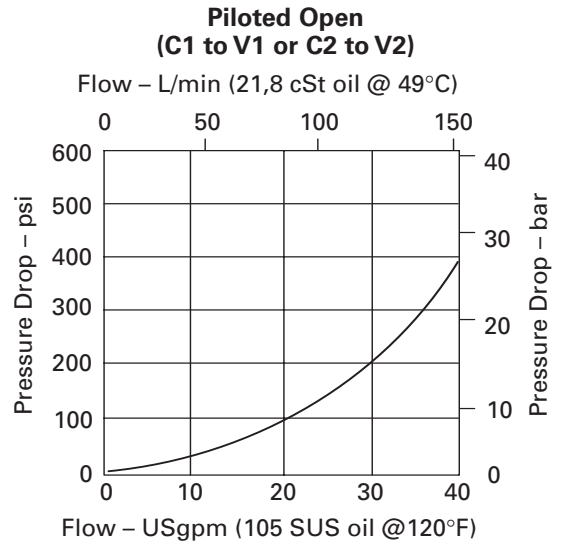
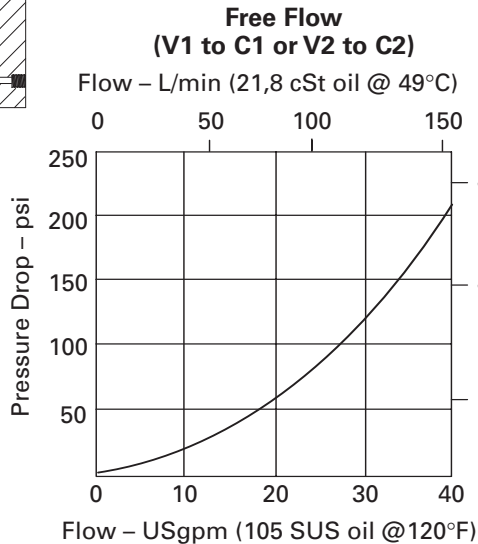



# Model Code

## MCV4 - 16 (V) - \* - \*\*\* - \*\*/\*\* - 00

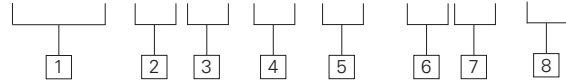

**1 Valve Function**  
**MCV4** - Dual-motion control valve

**3 Seals**  
**Blank** - Buna-N  
**V** - Viton®

**5 Port size**  
**12T** - SAE 12 (light duty)  
**6B** - 3/4" BSPP (light duty)

**7 Pressure setting**  
 Optional - specify in 100 psi ranges. If not specified, set at:  
**20** - 140 bar (2000 psi)  
**35** - 240 bar (3500 psi)

**2 Size**  
**16** - 16 Size

**4 Adjustment**  
**K** - Hand knob  
**S** - Screw with locknut

**6 Cracking pressure range**  
**13** - 3,4-8,4 bar (50-1300 psi)  
**35** - 13,6-240 bar (200-3500 psi)

**8 Special features**  
**00** - None  
 (Only required if valve has special features, omit if 00)

### Installation Dimensions

mm (inch)

Torque cartridge in housing  
 108-122 Nm (80-90 ft.lbs)

